



EasyTouch® Pool & Spa Control System Wireless Control Panel



Installation and User's Guide

IMPORTANT SAFETY INSTRUCTIONS
READ AND FOLLOW ALL INSTRUCTIONS
SAVE THESE INSTRUCTIONS

© 2009 Pentair Water Pool and Spa, Inc. All rights reserved

This document is subject to change without notice

1620 Hawkins Ave., Sanford, NC 27330 • (800) 831-7133 • (919) 566-8000
10951 West Los Angeles Ave., Moorpark, CA 93021 • (800) 831-7133 • (805) 553-5000

EasyTouch®, IntelliChlor®, IntelliFlo®, QuickTouch®, MagicStream®, IntelliBrite®, SAm®, SAL®, FIBERworks®, ThermalFlo® and Pentair Water Pool and Spa® are trademarks and/or registered trademarks of Pentair Water Pool and Spa, Inc. and/or its affiliated companies in the United States and/or other countries. Unless noted, names and brands of others that may be used in this document are not used to indicate an affiliation or endorsement between the proprietors of these names and brands and Pentair Water Pool and Spa, Inc. Those names and brands may be the trademarks or registered trademarks of those parties or others.

Contents

IMPORTANT SAFETY PRECAUTIONS	iii
EasyTouch Wireless Control Panel Kit Contents	v
Related Manuals	v
EasyTouch Accessories	v
Technical Support	vi
Section 1: EasyTouch Wireless Control Panel Overview	1
Introduction	1
Operating EasyTouch	1
EasyTouch Systems	1
EasyTouch Wireless Control Panel Overview	2
EasyTouch Wireless Control Panel Buttons	3
EasyTouch Wireless Control Panel Display	5
Battery Overview	6
Checking the battery charge	6
Power Save Options	7
Backlight Options	7
Installing Batteries	7
Quick Start - Pool and Spa Operations (Shared Equipment)	9
Heating the Spa/Pool	9
Schedule start and stop times for equipment	10
Controlling Lights	10
Setting up the EasyTouch wireless control panel	11
iS10 Spa-Side Remote Controller (Accessory)	12
iS4 Spa-Side Remote Controller (Accessory)	12
QuickTouch QT4 Wireless Remote Controller (Accessory)	12
Section 2 - Setting up the EasyTouch System	13
EasyTouch Menus	14
Main Screen	14
Feature Circuits Menu	15
Lights Menu	16
The Color Swim and Color Set Lighting Features	16
Setting up Lights	17
Assign the Circuit Name and Function	17
Setting up IntelliBrite Light Circuits	18
Lights Menu	18
Modes (IntelliBrite Color light shows, Color Swim, Color Set)	18
Modes (Color Swim)	18
Modes (Color Set)	19
Colors	19
Hold/Recall	19
All On / All Off (Lights Menu)	19
Sync	19
Config	20
Setting up SAM, SAL, PG2000, Color Wheel Lights	20
Setting up MagicStream Laminars	21
Using the MagicStream Laminars Features	22
Heat Menu	23
Pool Temp/Src	23
Spa Temp/Src	23
Delay Cancel Menu	24
Schedules Menu	25
Schedule your spa/pool to turn on	26
Using the Once Only feature	27
Using the Egg Timer (countdown) Feature	28
Settings Menu: Clock	29

Contents

Settings Menu: IntelliFlo (VS and VF)	30
Settings Menu: IntelliChlor	33
Settings Menu: ThermalFlo	34
Settings Menu: Circuit Names	35
Hi-Temp/Lo-Temp Controls for Single Body System	35
EasyTouch Circuit Names (Complete List)	36
Settings Menu: Circuit Functions	37
Freeze Protection	37
Preset Circuit Function Names (Complete List)	38
Settings Menu: Custom Names	39
Settings Menu: Valves	39
Settings Menu: 2-Speed Pump	40
Settings Menu: Solar	40
Settings Menu: Delays	41
Settings Menu: F° / C° (Fahrenheit/Celsius)	42
Settings Menu: iS4 Spa-Side Remote Controller	42
Settings Menu: iS10 Spa-Side Remote Controller	43
Settings Menu: iSx Pump Ctrl	44
Settings Menu: QuickTouch (QT4) Wireless Remote	45
Settings Menu: Man Heat (Off/On)	46
Settings Menu: Calibration	46
Settings Menu: Erase EEPROM (Erase System Memory)	47
Settings Menu: Set Password	47
Settings Menu: Backlight	48
Settings Menu: Power Save	48
Settings Menu: Wireless Addr	49
Spa Side [Off/On]	50
Diagnostics Menu: Software Rev	50
Diagnostics Menu: Bootloader Rev	51
Diagnostics Menu: Self Test	51
Diagnostics Menu: Chlorinator	51
Diagnostics Menu: Water Temp	51
Diagnostics Menu: Solar Temp	51
Diagnostics Menu: Air Temp	52
Diagnostics Menu: Cir Name: [Off/On]	52
Diagnostics Menu: Reset System	52
Diagnostics Menu: Flash Update	52
Section 3 - Troubleshooting	53
Frequently Asked Questions (FAQ)	53
EasyTouch Error Messages	54
Self Test Error Codes	54
Error Code Table	54
Maximum Programs Exceeded	55
IntelliChlor Error Messages	55
System Problem Diagnosis	56
EasyTouch System Wiring Diagram	58
First Time System Start-Up	59
Wiring a ThermalFlo Heat Pump to an EasyTouch Control System	60
Section 4 - EasyTouch Transceiver Installation	61
Glossary	65

IMPORTANT SAFETY PRECAUTIONS



Important Notice:

Attention Installer: This manual contains important information about the installation, operation and safe use of this product. This information should be given to the owner and/or operator of this equipment.

WARNING - Before installing this product, read and follow all warning notices and instructions which are included. Failure to follow safety warnings and instructions can result in severe injury, death, or property damage. Call (800) 831-7133 for additional free copies of these instructions.

WARNING - Water temperature in excess of 100 degrees Fahrenheit may be hazardous to your health. Prolonged immersion in hot water may induce hyperthermia. Hyperthermia occurs when the internal temperature of the body reaches a level several degrees above normal body temperature of 98.6° F (37° C). The symptoms of hyperthermia include drowsiness, lethargy, dizziness, fainting, and an increase in the internal temperature of the body.

The effects of hyperthermia include: 1) Unawareness of impending danger. 2) Failure to perceive heat. 3) Failure to recognize the need to leave the spa. 4) Physical inability to exit the spa. 5) Fetal damage in pregnant women. 6) Unconsciousness resulting in danger of drowning.

WARNING - To reduce the risk of injury, do not permit children to use this product unless they are closely supervised at all times.

WARNING - The use of alcohol, drugs, or medication can greatly increase the risk of fatal hyperthermia in hot tubs and spas.

WARNING - Control System is intended to control heaters with built-in high limit circuits **ONLY**. Failure to do so may cause property damage or personal injury.

WARNING - Do not use this product to control an automatic pool cover. Swimmers may become entrapped underneath the cover.

WARNING - For units intended for use in other than single-family dwellings, a clearly labeled emergency switch shall be provided as part of the installation. The switch shall be readily accessible to the occupants and shall be installed at least 10 feet (3.05 m) away, adjacent to, and within sight of, the unit.

CAUTION - Except for listed spa-side remote controls, install a minimum of five (5) feet from the inside wall of the pool and spa.

Two Speed Pump Controls Notice (Title 20 Compliance)

Please read the following important Safety Instructions (See page 40 for pump speed setup)

When using two-speed pumps manufactured on or after January 1, 2008, the pump's default circulation speed **MUST** be set to the **LOWEST SPEED**, with a high speed override capability being for a temporary period not to exceed one normal cycle, or two hours, whichever is less.

IMPORTANT SAFETY PRECAUTIONS (Continued)

General Installation Information

1. All work must be performed by a licensed electrician, and must conform to all national, state, and local codes.
2. Install to provide drainage of compartment for electrical components.
3. If this system is used to control underwater lighting fixtures, a ground-fault circuit interrupter (GFCI) must be provided for these fixtures. Conductors on the load side of the ground-fault circuit-interrupter shall **not** occupy conduit, junction boxes or enclosures containing other conductors unless such conductors are also protected by a ground-fault circuit-interrupter. Refer to local codes for details.
4. A terminal bar stamped  is located inside the supply terminal box. To reduce the risk of electric shock, this terminal must be connected to the grounding means provided in the electric supply service panel with a continuous copper wire equivalent in size to the circuit conductors supplying this equipment (no smaller than 12 AWG or 3.3 mm). The bonding lug(s) provided on this unit are intended to connect a minimum of one No. 8 AWG for US installation and two No. 6 AWG for Canadian installations solid copper conductor between this unit and any metal equipment, metal enclosures or electrical equipment, metal water pipe, or conduit within 5 feet (1.5 m) of the unit.
5. The electrical supply for this product must include a suitably rated switch or circuit breaker to open all ungrounded supply conductors to comply with Section 422-20 of the National Electrical Code, ANSI/NFPA 70.1987. The disconnecting means must be readily accessible to the tub occupant but installed at least 10 ft. (3.05 m) from the inside wall of the pool.
6. Supply conductor must be sized to support all loads. Maximum supply conductor current must be 125 Amps at 125 VAC.

Canada - Industry Canada (IC) - This device complies with RSS210 of Industry Canada. (1999). Operation is subject to the following two conditions: (1) this device may not cause interference, and (2) this device must accept any interference, including interference that may cause undesired operation of the device.

FCC Standard - 47 CFR Part 15, Subpart C (Section 15.247). This version is limited to chapter 1 to chapter 11 by specified firmware controlled in the U.S.A.

Instruction to user - This equipment has been tested and found to comply with the limits for a Class B digital device, pursuant to Part 15 of the FCC Rules. These limits are designed to provide reasonable protection against harmful interference in a residential installation. This equipment generates, uses and can radiate radio frequency energy and, if not installed and used in accordance with the instructions, may cause harmful interference to radio communications. However, there is no guarantee that interference will not occur in a particular installation. If this equipment does cause harmful interference to radio or television reception, which can be determined by turning the equipment off and on, the user is encouraged to try to correct the interference by one or more of the following measures:

- Reorient or relocate the receiving antenna.
- Increase the separation between the equipment and receiver.
- Connect the equipment into an outlet on a circuit different from that to which the receiver is connected.
- Consult the dealer or an experienced radio/TV technician for help.

Note: The user is cautioned that changes and modifications made to the equipment without the approval of the manufacturer could void the user's authority to operate this equipment.

⚠ RF Exposure Requirements: This Device must **not** be co-located or operated in conjunction with any other antenna or transmitter.

⚠ IC Regulatory Notice:

Operation is subject to the following two conditions: (1) this device may not cause interference, and (2) this device must accept any interference, including interference that may cause undesired operation of the device.

EasyTouch Wireless Control Panel Kit Contents

The following items are included in the EasyTouch wireless control panel kit. If any items are missing please contact Pentair Technical Support (see page vi).

- EasyTouch wireless control panel
- Four AA-size alkaline batteries
- EasyTouch transceiver module (with four plastic anchors and mounting screws)
- EasyTouch Wireless Control Panel User's and Installation Guide (this manual)

Related Manuals

- EasyTouch 8 and 4 Pool and Spa Control System User's Guide (P/N 520584)
- EasyTouch Indoor Control Panel User's and Installation (P/N 520617)
- EasyTouch 8 and 4 Installation Guide (P/N 520583)

EasyTouch Accessories



EasyTouch 8 Indoor Control Panel (P/N 520549)



EasyTouch 4 Indoor Control Panel (P/N 520548)



iS10 Spa-Side Remote Controller (P/N 520149)



iS4 Spa-Side Remote Controller (P/N 520094)



QuickTouch® wireless remote controller (P/N 520148)

EasyTouch Accessories (continued)

EasyTouch Indoor Control Panel, 4 Circuits	(P/N 520548)
EasyTouch Indoor Control Panel, 8 Circuits	(P/N 520549)
EasyTouch Wireless Control Panel, 4 circuits	(P/N 520546)
EasyTouch Wireless Control Panel, 8 circuits	(P/N 520547)
iS4 Four-Function Spa-Side remote, 150 ft. cable	(P/N 520094)
iS10 Ten-Function Spa-Side remote, 150 ft. cable	(P/N 520149)
Two-Speed Three HP Relay up to three additional valve actuators	(P/N 520198)
Three HP Power Relay	(P/N 520106)
QuickTouch four-function wireless remote kit with transceiver assembly	(P/N 520148)
IntelliChlor Acid Cleaning Kit	(P/N 520670)
IntelliChlor Spacer pass-through cell for new pool start-up	(P/N 520588)

Technical Support

Contact Technical Support at:

Sanford, North Carolina (8 A.M. to 5 P.M.)

Phone: (800) 831-7133

Fax: (919) 566-8920

Moorpark, California (8 A.M. to 5 P.M.)

Phone: (800) 831-7133 (Ext. 6312)

Fax: (805) 553-5515

Web sites: visit www.pentairpool.com and www.staritepool.com

EasyTouch® Wireless Control Panel Overview

Introduction

The EasyTouch wireless control panel gives you the freedom to control your pool and spa daily operations from around your pool and spa area. The wireless device can operate up to 300 feet from the EasyTouch transceiver module which is typically located near the EasyTouch load center. There is enough battery power to operate the whole summer season without changing batteries. Using the power saving menu options you can also reduce power consumption and extend battery life. The EasyTouch wireless control panel is water resistant, however, it's not intended to be submersible.

Operating EasyTouch

The EasyTouch system is designed to automatically control your pool and spa equipment, lights and other optional equipment. However, you can also manually control all EasyTouch system operations from the outdoor control panel. Using the “Mode” button, the system can be switched from “Auto” mode (normal operating mode) to “Service” mode for manual operation and service purposes. Using the outdoor control panel buttons you can manually override any automatic settings. If required, the EasyTouch wireless control panel can be password protected. To access a password protected control panel, the correct four digit password must be entered before access is granted (see page 47).

EasyTouch Systems

There are two EasyTouch system configurations available; EasyTouch 8 (auxiliary circuits) and EasyTouch 4 (auxiliary circuits). The EasyTouch system is factory configured to operate with a “shared” equipment system or with a “single body” system. For EasyTouch 4 and EasyTouch 8 menus, see page 13.



EasyTouch Wireless Control Panel (eight auxiliary circuits)

EasyTouch Wireless Control Panel Overview

The EasyTouch Wireless Control Panel makes it easy for you to control your pool and spa daily operations from inside your home. Using the “Pool” and “Spa” buttons allows one touch control to heat and filter your spa and pool. EasyTouch automatic system operations can be performed either at the Wireless Control Panel or from the outdoor control panel. The Wireless Control Panel connects to the motherboard in the EasyTouch load center.

Pool (Lo-Temp) Button: Switches the filter pump on, rotates valve actuator (to isolate pool water from spa water), and switches heater on. Lo-Temp (EasyTouch single body system) sets the low temperature settings for the pool, see page 35.

For details about the control panel LCD status messages, see page 5.

Set Temperature buttons, see page 4.

Power ON, Menu/Back button, see page 4.

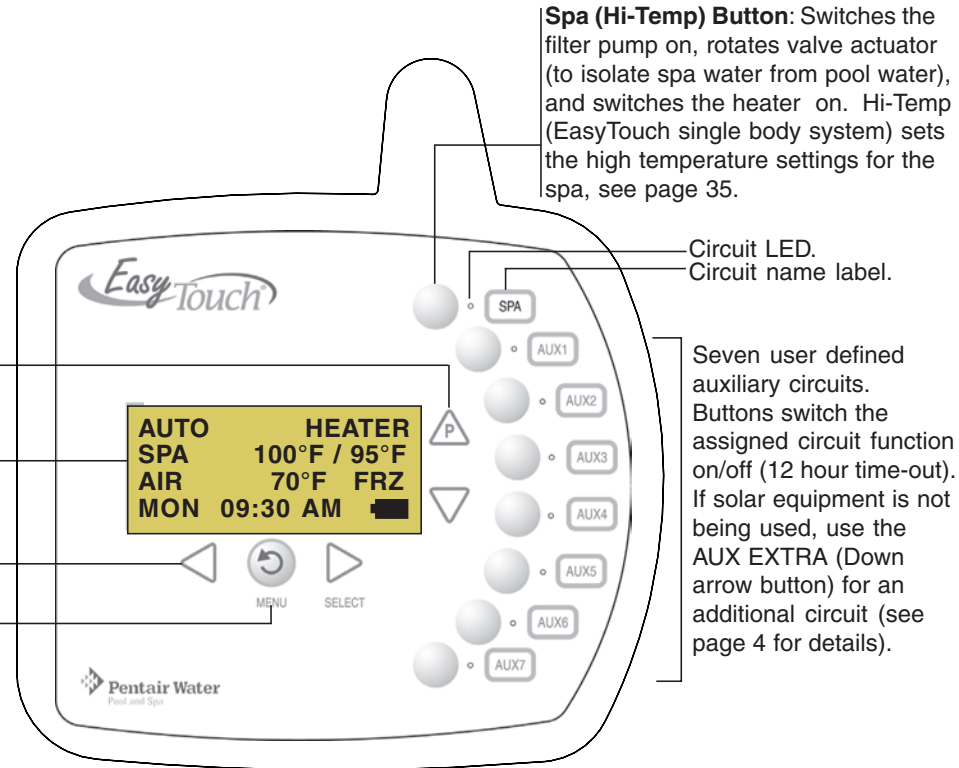

Spa (Hi-Temp) Button: Switches the filter pump on, rotates valve actuator (to isolate spa water from pool water), and switches the heater on. Hi-Temp (EasyTouch single body system) sets the high temperature settings for the spa, see page 35.

Circuit LED.
Circuit name label.

Seven user defined auxiliary circuits. Buttons switch the assigned circuit function on/off (12 hour time-out). If solar equipment is not being used, use the AUX EXTRA (Down arrow button) for an additional circuit (see page 4 for details).

Wireless Control Panel (EasyTouch 8) - (P/N 520547)

Pool (Lo-Temp) Button: Switches the filter pump on, rotates valve actuator (to isolate pool water from spa water), and switches heater on. Lo-Temp (EasyTouch single body system), can be assigned for low temperature setting, see page 35.

Set Temperature buttons, see page 4.

Power ON, Menu/Back button, see page 4.

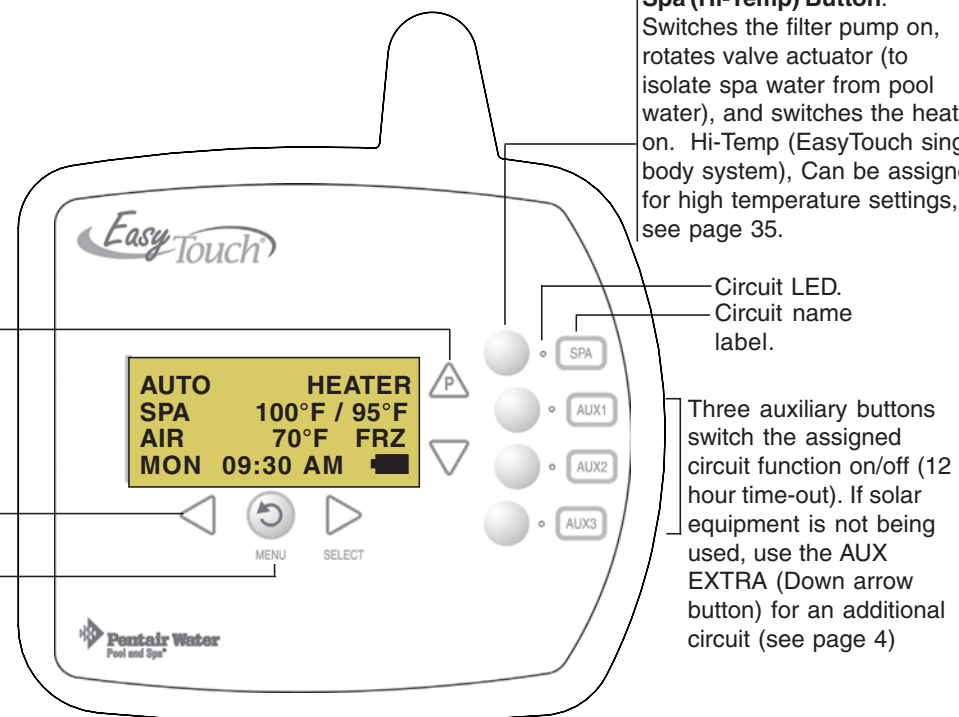

Spa (Hi-Temp) Button: Switches the filter pump on, rotates valve actuator (to isolate spa water from pool water), and switches the heater on. Hi-Temp (EasyTouch single body system), Can be assigned for high temperature settings, see page 35.

Circuit LED.
Circuit name label.

Three auxiliary buttons switch the assigned circuit function on/off (12 hour time-out). If solar equipment is not being used, use the AUX EXTRA (Down arrow button) for an additional circuit (see page 4)

Wireless Control Panel (EasyTouch 4) - (P/N 520546)

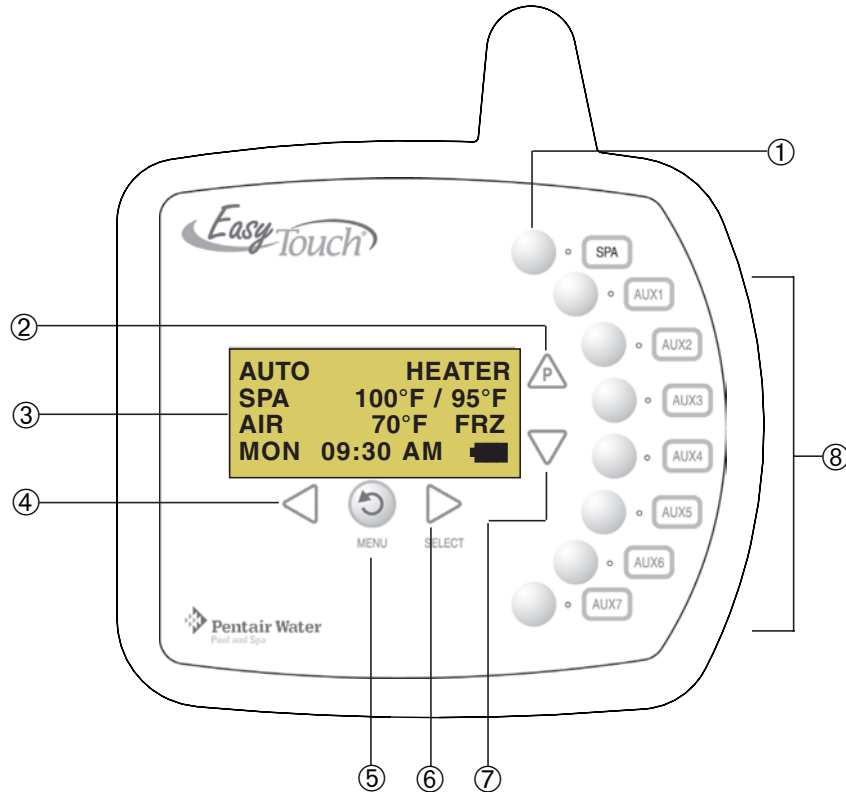

EasyTouch Wireless Control Panel Buttons

You can fully automate your pool, spa, and lighting operations from the EasyTouch Wireless Control Panel or from the EasyTouch outdoor control panel located at the pool equipment pad. The EasyTouch menu features let you create customized schedules for your pool and spa equipment, heat temperatures, and chlorination



EasyTouch Wireless Control Panel

EasyTouch Wireless Control Panel Buttons

- ①  **Spa button/LED:** For spa operations. Press the Spa button to activate the filter pump, rotate the pool/spa valve actuators and circulate the spa water (LED on). Press the button again to switch the filter pump off (LED off). While the valves are rotating into position the filter pump will switch off. For service or testing purposes, if the heater is enabled in the Heat menu, pressing this button will also activate the heater. For normal spa operations the heater is automatically switched on with the filter pump (see Man Heat page 46) regardless of the Heat menu setting. When this button is pressed the circuit is activated, the LED is on and “SPA” is displayed on the screen with the current and set point water temperatures. Once the filter pump is switched on it will run for 12 hours unless it is switched off. When this button is pressed, the LEDs on the outdoor control panel Filter Pump (F) button, Valves (V) button, and Heater button (if enabled in the Heat menu) will be on. If this display line is blank, it indicates no spa or pool function is currently active.
- ②  **Pool Button:** For pool operations. Press the Pool (P) button to activate the filter pump, rotate the pool/spa valve actuators and circulate the pool water and switch on the heater (if enabled in the Heat menu). Press the button again to switch the filter pump off. While the valves are rotating into position the filter pump will switch off. When this button is pressed the circuit is activated and “POOL” is displayed on the screen with actual and set point water temperatures. When the filter pump is switched on it will run for 12 hours unless it is switched off. When this button is pressed, the LEDs on the outdoor control panel Filter Pump (F) button, Valves (V) button, and Heater button (if enabled in the Heat menu) will be on. If this display line is blank, it indicates no pool or spa function is currently active.

Controls and buttons (Continued)

Pool button (Continued)

- **Single-Speed Filter Pump:** If the pump is currently off, press the Pool button to switch the pump on. Press the Pool button again to switch the pump off. However, if the heater is operating, and a delay is enabled for valves, this allows the heater to cool down (heater cool-down), then when you press the Pool button to switch off the pump, only the heater will turn off, then the filter pump will automatically switch off after 10 minutes to allow the heater to cool down. Pentair Water Pool and Spa® heaters do not require a cool down time. To override the “heater cool-down,” press the Pool button again to switch off the pump.

- **Two-Speed Filter Pump:** Press the Pool button to switch the two-speed pump on in high speed. Press the Pool button again to run the pump in low speed. In order to use the “2-Speed Pump” menu assignments (see page 29), the 2-Speed relay option must be installed in the EasyTouch Load Center.



Notes about Freeze Protection: This function protects the pool, plumbing, and equipment against freeze damage. If the outside air temperature sensor falls below 36° F (2° C), “Freeze Protection” is activated and the Filter Pump relay is switched on to circulate the pool water. To enable freeze protection for a circuit, see “Settings Menu: Circuit Functions,” on page 37.

③ **Liquid Crystal Display (LCD):** The main system display consists of a 16 x 4 alphanumeric character LCD with EL backlighting for easy viewing of the menu items, and status messages. Press the Menu button twice to refresh the display. For main screen status information, see page 5.

④  **Left button:** When in pool or spa mode, press the Left button to lower the set point water temperature. Press the Spa or Pool (Up arrow **P**) button (page 3) to display the current water temperature. While in the main menu, press the Left button to scroll through sub-menu selections, setting and values. While editing settings, press and hold the Left button to fast reverse through settings and values.

⑤  **Power ON, Menu/Back button:** Use this button to power on the EasyTouch wireless control panel if there has been no button activity for 60 seconds (see page 48). The Menu/Back button to access, save and exit the EasyTouch system menu settings. Use this button to exit from main menu or sub-menu items. Pressing the Menu/Back button while in a menu item will return to the main status screen. If no menu activity is detected after five minutes, the main screen is displayed. All menu settings are permanently saved and retained in the control panel even after power is removed from the control panel. Control panel buttons are disabled while in “menu” mode.

⑥  **Right button:** When in pool or spa mode, press the Right button to raise the set point water temperature. Press the Spa or Pool (Up arrow **P**) button (page 3) to display the current water temperature. Press the Right button to select a sub-menu item for editing. After pressing the Menu button to access the main menu items, press the Right button to select the menu item and access the sub-menu items for adjustment. While editing a settings, press and hold the Right button to fast forward through settings and values.

⑦ 
 **Up/Down buttons:** Press the Up and Down buttons to scroll through the main menu items and to adjust or change settings. Use these buttons after pressing the Menu button to access the main menu items. While editing settings, press and hold the Up or Down button to fast forward or fast reverse through settings and values.

 **Down arrow button (Aux Extra):** This button switches the assigned circuit on or off. This “extra” auxiliary circuit shares the solar circuit and is only available if the solar output plug (J17) on the motherboard is not being used for solar equipment. Refer to the EasyTouch User’s Guide (P/N 520584) for more information.

Controls and buttons (Continued)

- ⑧  **AUX buttons/LEDs:** The auxiliary output circuit buttons operate the pool and spa system valve actuators, lights and other equipment. The auxiliary (AUX) relay circuits are assigned in the “Circuit Functions” menu, see page 37 for details. There are three auxiliary circuits (AUX 1- 3) on the EasyTouch 4 Wireless Control Panel and seven auxiliary circuits (AUX 1- 7) on the EasyTouch 8 Wireless Control Panel. The Down arrow button can also be used as an “extra” auxiliary circuit if solar equipment is not being used. Refer to “Down arrow button” on page 4 for more information. Labels can be affixed next to each auxiliary button to identify the circuit function. When an auxiliary circuit is activated or the button is pressed, the LED is on. Pressing an auxiliary circuit button will activate the corresponding circuit in either “Auto” or “Service” mode. When a circuit relay is switched on manually, it remains on until either you switch it off manually, or the next time the relay is scheduled to be switched off. For example, if the filter pump is scheduled to automatically run from 9:00 AM to 5:00 PM daily then the filter pump is switched on manually at 9:00 PM, it will run continuously until the next day at 5:00 PM then switch off. The schedule will then continue from then on. AUX buttons are disabled while in the main menu.

EasyTouch Wireless Control Panel Display

The Wireless Control Panel screen displays when the system is in automatic mode (AUTO) or in service mode (SERVICE). Service mode is enabled from EasyTouch outdoor control panel at the pool equipment pad. The following describes the main status screen.

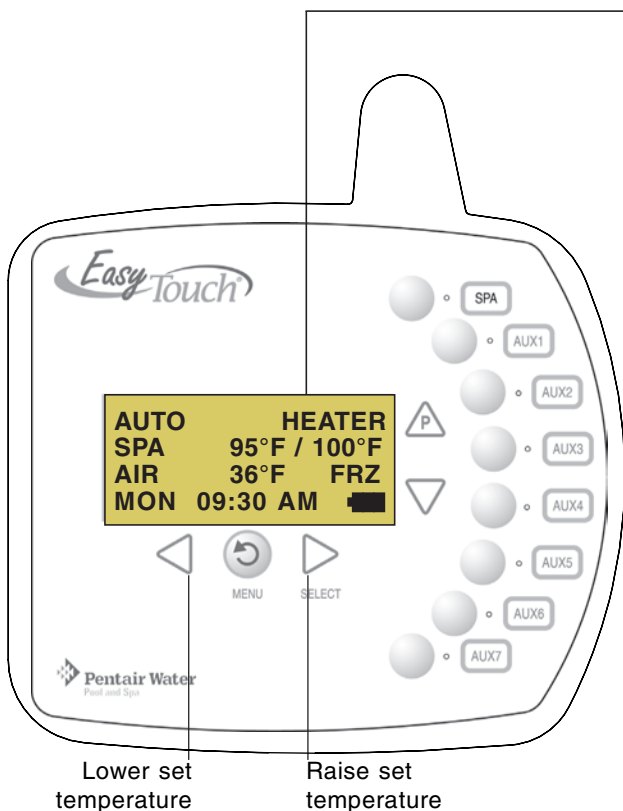

AUTO (Automatic): The system is in normal operating mode. Scheduled programs will run automatically. SERVICE or TIMEOUT mode are displayed when the system is being serviced. These modes are activated from the EasyTouch Outdoor Control Panel.

HEATER: Heater is switched on. Displays when the Pool (P) or Spa button is pressed. For pool operations the heat source must be enabled in the Heat menu (see page 23). Displays “Solar” or “Solar Prf” if solar is enabled. The heater is active when the set temperature is higher than the water temperature. The heater will switch off when the water temperature rises above the set temperature.

SPA (Hi-T) or POOL (LO-T) : Displays when the Spa/Hi-T or Pool/LO-T button is pressed to rotate valve actuators and activate the filter pump and heater. This line on the screen is blank when no spa or pool function is active. Note: Depending on the EasyTouch system, the screen displays SPA (shared equipment), HI-T (single body of water system), POOL (shared equipment), LO-T (single body of water system).

95° F / 100° F: Displays the actual spa or pool water temperature (95° F) and the set point temperature (100° F) as set in the Heater menu. Degree units are displayed in either Fahrenheit or Celsius.

AIR: Displays the actual outside air temperature (70° F) as read by the air sensor located near the EasyTouch Load Center. Degree units are displayed in either Fahrenheit or Celsius (see page 42).

FRZ: Displays when freeze protection is active. To protect pool system equipment, freeze protection must be enabled for the filter pump circuit. If the outside air temperature sensor detects the temperature is getting close to freezing point (below 36° F (2° C)), the freeze protection feature switches on the filter pump circuit to circulate water through the system. For more information, see page 37.

DEL: Displays when “Delay Cancel” is active. For more information, see page 24.

Date and Time: Displays the EasyTouch system day and time as specified in the “Clock” menu setting (see page 29).

 **Battery icon:** Displays the available battery power usage for the device. See page 6 for details.

The average battery life for the EasyTouch wireless control panel can last the summer season with normal use. Battery life varies depending on the type of batteries used and the amount of usage. The following battery types are compatible with the EasyTouch wireless control panel:

- AA-size alkaline battery (four provided in the kit)
- AA-size Ni-MH rechargeable battery (four purchased separately)

Safety Precautions when using batteries

Read the following important information before installing batteries into the EasyTouch wireless control panel.

- Never use batteries with split or peeling outer casings
- Never use combinations of different types of batteries or new and used batteries together
- Do not use manganese or Ni-Cd batteries
- Ensure that batteries poles are clean. Dirty poles can shorten battery life
- The time for which AA-size alkaline batteries can be used vary depending on the brand. Some brands may provide less power than others. Note that the time Alkaline batteries can be used decreases in cold conditions (0° C to 10° C (32° F to 50° F)). Therefore, it is recommended to use AA-size Ni-MH batteries in the unit.
- When first purchased, or if left unused for a long period, the amount of time that the AA-size alkaline, Ni-MH, or rechargeable batteries can be used, may be shortened.

Checking the battery charge

A check battery status icon displays on the main screen of the EasyTouch wireless control panel. The check battery icon is located in the lower right corner of the main screen.

AUTO	HEATER
SPA	95°F / 100°F
AIR	70°F
MON	09:30 AM 

Check battery icons



Ample battery charge.



Sufficient charge left in the batteries to operate the unit. The unit's estimated battery life varies greatly depending on use and backlight display time (see page 7).



Batteries are depleted. Before the batteries are completely depleted this icon will start flashing, indicating that the LCD will shortly go blank and the EasyTouch wireless will stop working. Replace or recharge the batteries. Depending on the type of batteries installed, this icon may display more quickly.

Power Save Options

Use the power save function to reduce power consumption and extend battery life. The power save options are:

- **Idle Time:** If there is no control panel activity, the idle time can be set to 60 seconds (default), 30 seconds, or five minutes before it shuts down. The default time is 60 seconds. For information about accessing the idle time options menu, see page 48.

Note: If the unit is not used for 60 seconds the power save function switches off the unit. To switch the unit on, press the POWER ON button (see page 4).

Backlight Options

Use the backlight on time power save options to reduce power consumption and extend battery life. To access the Backlight options menu, see page 48. The backlight options are:

- **On Time:** Backlight is on for 60 seconds, 30 seconds, five minutes, or off. The default setting is 30 seconds.
- **Brightness:** Backlight brightness can be set to low, medium or high. The default setting is medium.

Installing Batteries

The EasyTouch wireless control panel is shipped with four AA-size alkaline batteries. Before using the unit install the batteries.

To install batteries:

1. Place the EasyTouch control panel face down on a flat clean surface. Remove the six screws securing the battery cover. Set the cover aside.

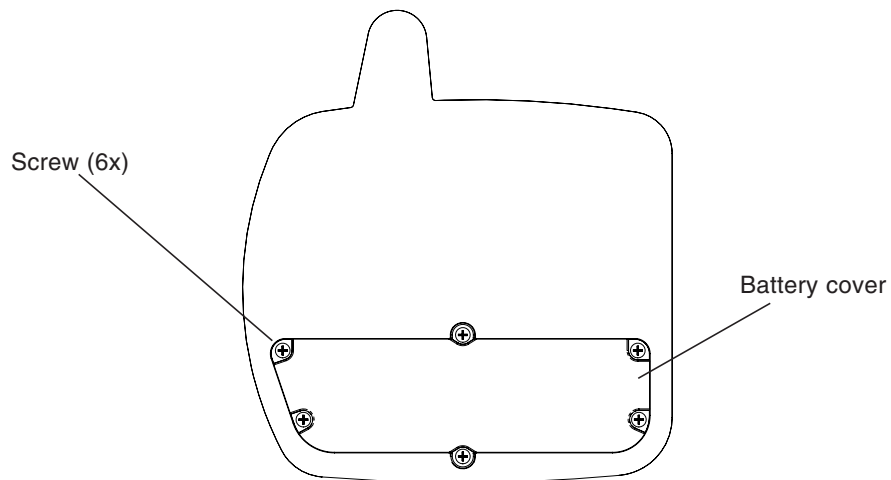

Easy Touch Control Panel (rear view)

Installing batteries (Continued)

2. Load the four batteries into the battery compartment. Orient the positive polarity end of each battery as shown below.

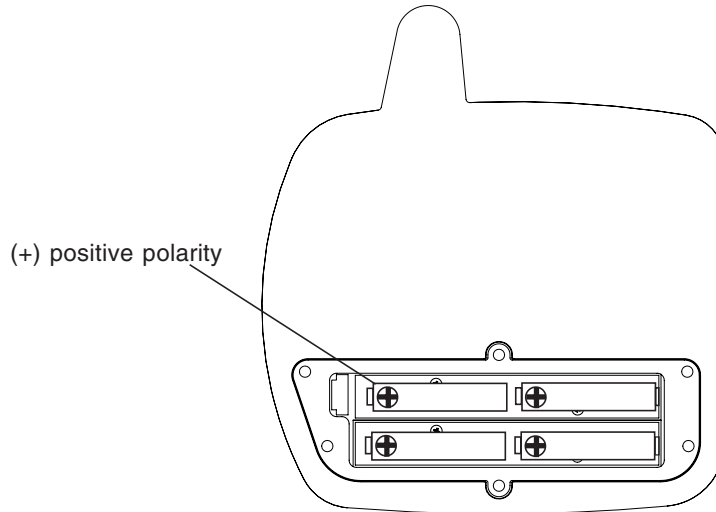

3. Install the battery cover and secure with the six screws. Make sure that the battery cover is secure and that all the screws are hand tightened. **CAUTION - DO NOT OVERTIGHTEN THE SCREWS. OVERTIGHTENING THE SCREWS CAN DAMAGE THE UNIT.**

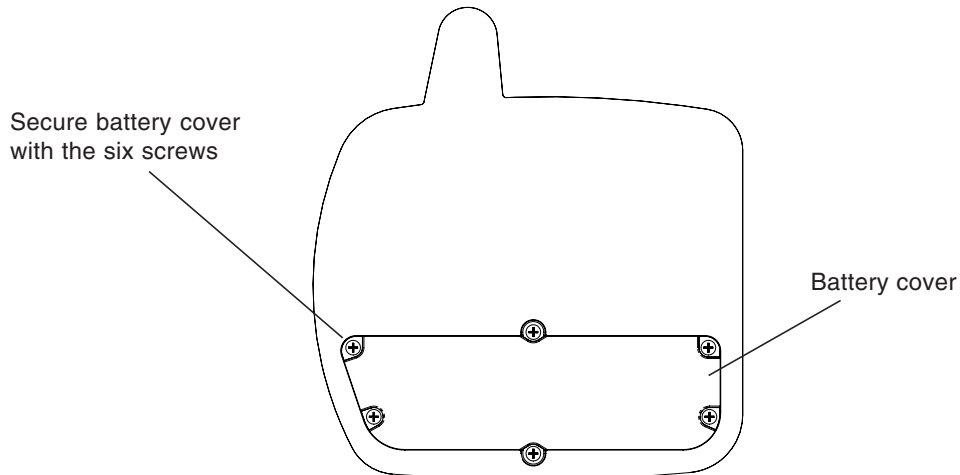

Easy Touch Control Panel (rear view)

4. **Power up the unit:** To switch the unit on, press the **Power On** button located on the front of the unit.
5. **Display messages after replacing batteries:** After replacing depleted batteries a check battery message is displayed on the screen. Press the **MENU** button to continue.
6. The screen will then display a second message to check the battery cover. After checking that the battery cover is secure and that all screws are tightened, press the **MENU** button.
The battery icon should display the fully charged icon (■). The unit is ready for use.

Quick Start - Pool and Spa Operations (Shared Equipment)

The following describes how to adjust heat temperature for the spa and pool water, schedule a daily run time for the pool/spa filter pump and control lights for shared equipment.

Heating the Spa

Heating the spa water on demand is easy, just press the **SPA button** to switch the heater on and display the current temperature settings on the EasyTouch Wireless Control Panel. “Heater” will be displayed on the screen when the heater is active. The heater is active when the set temperature is higher than the water temperature. The heater will switch off when the water temperature rises above the set temperature. For more information about the spa manual heating “MAN HEAT” feature, see page 46. Pressing the Spa button will switch the filter pump on and rotate the spa valve actuator to isolate and circulate the spa water from the pool water.

Heating the Pool

Heating the pool water is normally part of the daily scheduled program (see page 25). However, if you need to adjust the pool water temperature, press the **Pool (P) button** to display the current temperature settings on the EasyTouch Wireless Control Panel. “Heater” will be displayed on the screen when the heater is active and a heat source has been selected in the Heat menu. The heater is active when the set temperature, as specified in the Heat menu, is higher than the water temperature. For more information about selecting a heat source and setting the pool water temperature setting, see page 23. Pressing the Pool button will switch the filter pump on and rotate the pool valve actuator to isolate and circulate the pool water from the spa water.

Adjusting the water temperature setting

To adjust the set temperature setting for the pool or spa water, either use the **Left arrow button** to lower the temperature setting or the **Right arrow button** to higher the temperature setting.

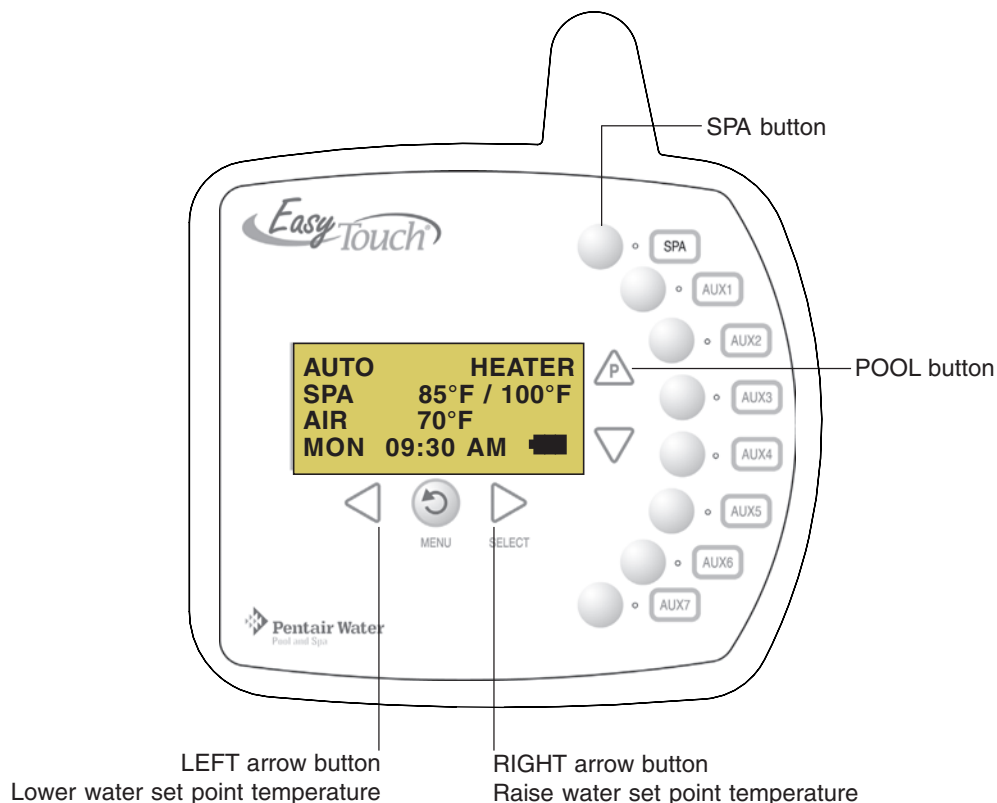

EasyTouch Wireless Control Panel

Quick Start - (Pool and Spa Operations (Shared Equipment) Continued

Schedule start and stop times for equipment

From the Schedules menu you can set the a start and stop time to automatically run pool and spa equipment and control underwater and backyard lights. For example, the filter pump relay circuit can be scheduled to run the daily pool and spa filtration at a specific time and day(s) of the week. Up to 12 total program schedules may be created for all relay circuits combined. The pool and spa circuits can also be scheduled to switch on the heater to heat the pool or spa water up to the set point temperature as set in the “Heat” menu (see page 23). If the pool has a separate jet pump or blower controlled by AUX 1 and/or AUX 2 , these need to be scheduled separately.

Schedules

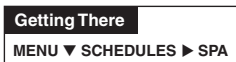

To create a schedule to heat the spa:

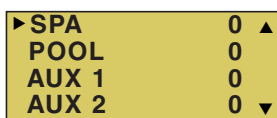

Right button: Select the **Spa** circuit. The standard generic circuit names are: Spa, Pool, Aux 1-7, Feature 1-8 (EasyTouch 8), Aux 1-3, Feature 1-4 (EasyTouch 4), and Aux Extra “Aux Extra” is only available if the Solar output (J17) plug on the EasyTouch motherboard is not being used for solar equipment.

Right button: Select **Mode** if there are existing programs. Skip this step to create a new program.

Up/Down button: Select **New** to create a new program.

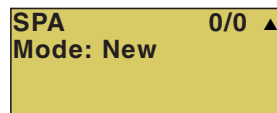

Right button: To create a new program and enter the Mode settings.

Up/Down button: 1/1 indicates that this circuit has one program. If there are existing programs assigned to this circuit, use these buttons to view and select the existing program settings.

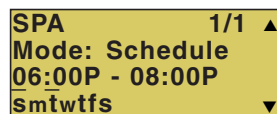

Right button: To select the Schedule settings. **Right button:** Move to start and stop time settings.

Up/Down and Right buttons: Set start and stop hour (A/P), minutes.

The A (AM) and P (PM) time is set when setting the start and stop hour (6:00 PM to 8:00 PM).

Right button: Move to days of the week to run the program.

Right and Up/Down buttons: By default the program is set to run all the days of the week. If you wish to edit which days to run the program, select the day of the week, then press the **Up/Down** button to remove the bar from the top of the letter. A bar on top of the letter indicates the day selected to run the program. In this example Sunday and Tuesday are scheduled.

Press the **Menu** button to save the settings and to return to the Schedules menu options. Press the button again to return to the main menu options or press again to return to the Main screen.

Controlling Lights

From the Lights screen you can manually switch all lights on or off, configure and synchronize colored lights. For more information about setting up IntelliBrite colored show modes, fixed colored lights, *SAm* and *SAL* Color Swim and Color Set modes, refer to the Lights Menu on page 16.



To manually switch on or off all lights:

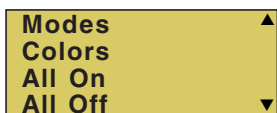

Up/Down button: Select: **All Off** or **All On**.

Press the **Menu** button save the settings and to return to the main menu items or press the button again to return to the Main screen.

Setting up the EasyTouch wireless control panel for the first time

Setting up the EasyTouch wireless control panel

In order for the EasyTouch wireless control panel to communicate with the EasyTouch system outdoor control panel, the first time the wireless device is powered up it must first be assigned a unique communication address. For this process you need to access the menu for each control panel. For convenience it's easier to set up the wireless device at the outdoor control panel.

Note: Before you start verify that the transceiver antenna is connected to the EasyTouch load center. For installation instructions, refer to "EasyTouch Transceiver Installation," on page 61.

From the EasyTouch load center outdoor control panel

1. Switch power on to the EasyTouch load center.
2. Press **Menu** button, and select **Settings > Address** and press the **Right** arrow button.



The EasyTouch outdoor control panel will display "Scanning..." for about five seconds while it searches for the EasyTouch wireless device within range of the transceiver antenna. After the scanning process has finished, "Sending Address" is displayed. The system is now waiting to lock on to the EasyTouch wireless control panel. Proceed to step 3.

From the EasyTouch wireless control panel

3. Press the **Power On** button located on the front of the wireless device.

Note: After replacing depleted batteries a check battery message is displayed on the screen. Press the **MENU** button twice to continue.
4. Press **Menu** button, and select **Settings > Address** and press the **Right** arrow button.
5. Select "Address" and press the **Right** arrow button to lock on to the unique address that is being transmitted from the outdoor control panel.

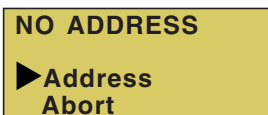

Note: If you choose "Abort," the device can continue to operate using the factory default address. If the outdoor control panel has been previously addressed, the wireless may not operate the system. Each time the device is switched on the "NO ADDRESS" will be displayed. This mode is not recommended for permanent use.

6. After selecting "Address" the wireless device unit will lock on to a unique address and display "Found ADDRESSED." Press the **Menu** button to save and exit this mode. The device is ready for operation. If "Unit Mismatch" displays

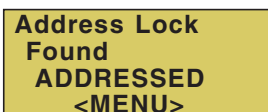

Note: "Unit Mismatch" displays if the outdoor control panel has an existing system image. See page 12 for details.



7. **On the outdoor control panel:** Press the outdoor control panel **Menu** button three times to exit the "Sending Address" mode and return to the main screen. The system will continue to transmit an address until the Menu is button is pressed to stop the process.

Note: To readdress the EasyTouch wireless device, repeat steps 2 through 7 on the wireless device to restart the address process.

Synchronizing control panels

If the EasyTouch outdoor has been previously setup with specific pool and spa information and you install the EasyTouch wireless control panel with factory default information, the outdoor control panel will automatically download the existing system information to the wireless control panel. If the wireless control panel has a different firmware revision level than the outdoor control panel or it contains previous setup information, you can choose which system image to upload or download. Synchronizing the control panels is initiated from the wireless control panel. The following describes how to synchronize the wireless control panel with the outdoor control panel.

Download from outdoor to wireless control panel

- Press the Menu button to download the system image from the EasyTouch outdoor control panel to the wireless control panel.



Upload to outdoor from wireless control panel

- Press the **Up/Down** button to access the “Upload” screen.
- Press the Menu button to upload the system image from the wireless control panel to the EasyTouch outdoor control panel.



Note: To erase existing control panel system information, use the “Erase EEPROM” feature. Refer to “Erase EEPROM” on page 46 for more information.

iS10 Spa-Side Remote Controller (Accessory)

An iS10 Spa-Side remote controller can control up to ten functions including a spa temperature adjustment. The iS10 Spa-Side remote controller is listed UL (1563) for use with the EasyTouch systems at the water’s edge. Five (5) in-line buttons control up to ten (10) system functions. The iS10 includes an LED display shows the current spa water temperature. The temperature display will blink while being changed. For more information about assigning iS4 buttons to circuits, refer to “Settings Menu: iS4 Wireless Remote,” on page 44.



iS10 Spa Side Remote Controller (P/N 520149)

iS4 Spa-Side Remote Controller (Accessory)

The iS4 Spa-Side remote controller provides remote switching of up to four control circuits from the spa location. For more information about assigning iS4 buttons to circuits, refer to “Settings Menu: iS4 Wireless Remote,” on page 44.



iS4 Spa-Side Remote Controller
(Wall or tile mount)



iS4 Spa-Side Remote Controller
(Deck mount)

QuickTouch® QT4 Wireless Remote Controller (Accessory)

The QuickTouch QT4 wireless controller provides four on and off buttons to activate pool and spa auxiliary circuits. For more information about assigning QT4 buttons to circuits, refer to “Settings Menu: QuickTouch (QT4) Wireless Remote,” on page 44.



QuickTouch (QT4) wireless remote controller (P/N 520148)

Section 2 EasyTouch Menus

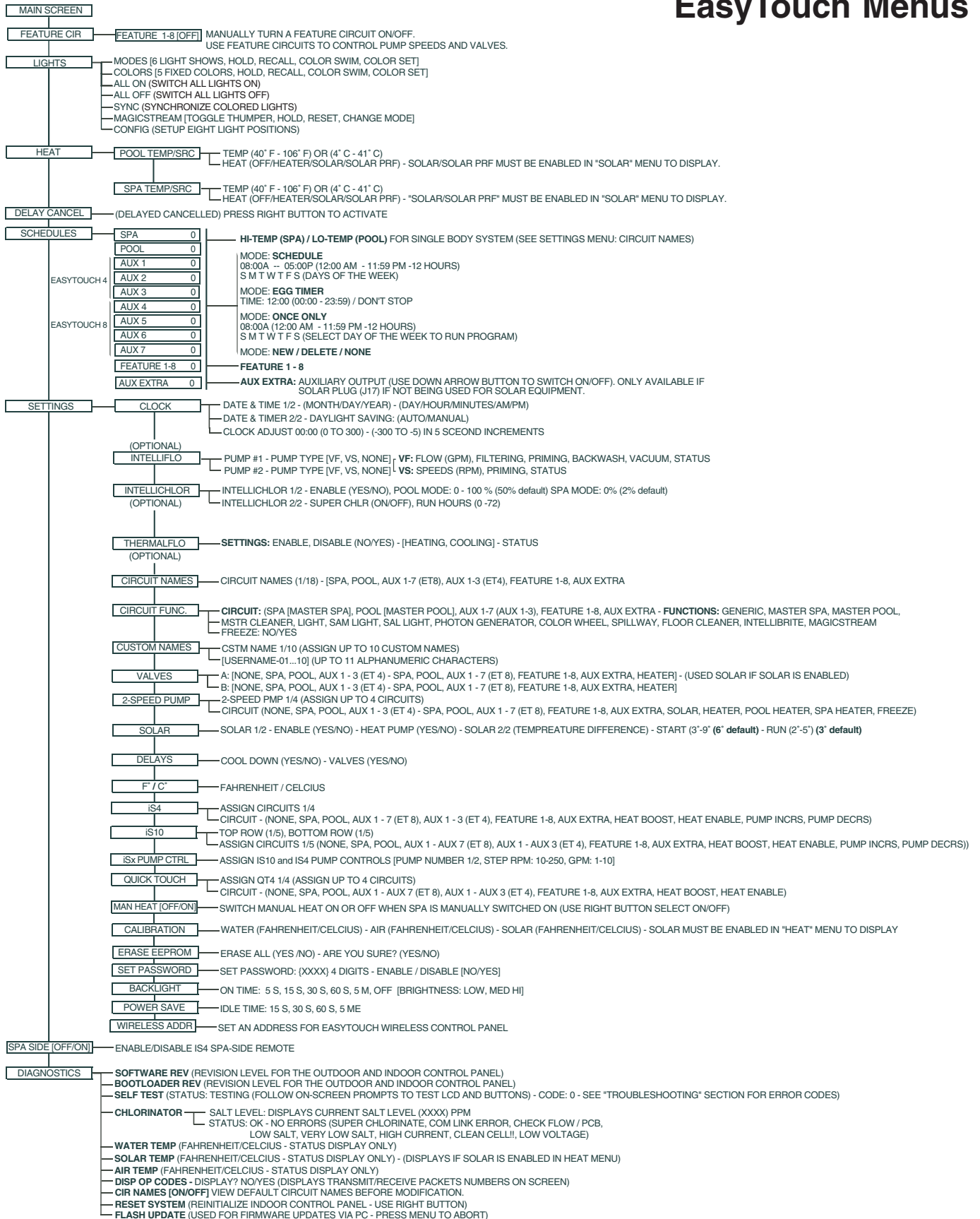

EasyTouch Menus

From the EasyTouch control panel menus you can schedule everyday pool/spa, heating, filtration and cleaning. Lights and laminars can also be scheduled to switch on and off at specific times. The “Settings” and “Schedule” menus are typically used most often for daily spa and pool operations. The “Settings” menu is used by the pool installer to setup installed equipment which is connected to each output relay (filter pump, auxiliary relays, heater, valves, lights, etc.). For EasyTouch equipment installation instructions, see the EasyTouch Installation Guide (P/N 520584).

Main Screen

AUTO	HEATER
SPA	95°F / 100°F
AIR	70°F
MON	09:30 AM

AUTO	HEATER
POOL	85°F / 95°F
AIR	70°F
MON	10:30 AM

AUTO	
AIR	70°F
MON	11:30 AM

The EasyTouch main screen displays the current mode of operation (AUTO/SERVICE/TIMEOUT), heat source being used, spa (or pool) actual water temperature (95° F), current heater set point temperature (100° F) and the current ambient air temperature (air sensor). Degree units can be displayed in either Fahrenheit (default) or Celsius (see page 42). If the second display line is blank and the heat source is not displayed, there is no spa or pool function currently active. The main screen is automatically displayed if there is no control panel menu activity for five minutes. If there is an IntelliChlor® salt chlorinator generator being used, pool and spa sanitizer settings, and salt levels can be viewed in the Diagnostics, “Chlorinator,” settings (see page 51).

Main Screen Description

AUTO: EasyTouch is in normal (automatic) operating mode. For information about “Service” and “Timeout” operating modes, see page 4.

HEATER: The selected heat source as selected in the “Heat” menu (see page 23). The heat options are:

- **OFF** - No heating even though pump and other circuits may be operating.
- **HEATER** - Gas heater only.
- **SOLAR ONLY** - Solar heating system to be the only heat source. In order to display “Solar Pref.” on the main screen, you must first enable solar in the “Solar” menu (see page 40).
- **SOLAR PREF.** - (Solar Preferred) - For when solar and gas heating are combined, and you want to use solar heating only when it is most effective. In order to display “Solar Pref.” on the main screen, you must first enable solar in the “Solar” menu.

SPA: “SPA” is displayed after the **Valves (V)** button is pressed to set in “spa” mode then the **Filter (F)** button is pressed to switch the filter pump on, rotate the valve actuator (to isolate spa water from pool water), and switch the heater on (if enabled in the “Heat” menu). Pressing the **Valves (V)** button alternates between “Pool” and “Spa” mode. The temperature unit displayed on the left side is the actual water temperature (95° F) and the set point temperature (100° F) as set in the “Heat” menu is displayed on the right side. If this display line is blank, it indicates no spa or pool function is currently active. For Hi-Temp controls (EasyTouch single body system), see page 35.

POOL: “POOL” is displayed after the **Filter (F)** button is pressed to switch the filter pump on, rotate the valve actuator to isolate the pool water from the spa water, and switch the heater on (if enabled in the “Heat” menu). Pressing the **Valves (V)** button alternates between “Pool” and “Spa” mode. The temperature unit displayed on the left side is the actual water temperature (95° F) and the set point temperature (100° F) as set in the “Heat” menu is displayed on the right side. If this display line is blank, it indicates no spa or pool function is currently active. For Lo-Temp controls (EasyTouch single body system), see page 35.

AIR: Displays the actual outside ambient air temperature (70° F) as recorded by the air sensor located near the EasyTouch load center.

DAY and TIME: The current system day and time (AM/PM). See the “Clock” menu to set the system day and time (page 29).

Feature Circuits Menu

There are eight (8) “Feature Circuits” that can be used to control IntelliFlo® pump speeds or valves actuators for a spa spillway. Unlike an auxiliary relay circuit, a “Feature” circuit does not connect directly to a relay. “Feature” are turned on and off from the control panel “Feature” circuit menu.

Feature Circuits



To switch a feature circuit ON or OFF:

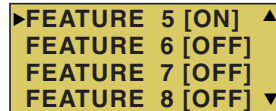
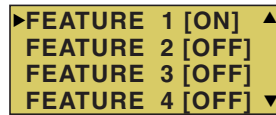
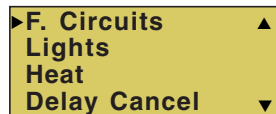

Right button: Select the feature circuit to turn ON or OFF.

Up/Down buttons: Choose assigned feature circuit: FEATURE 1 - 8.

Right button: Switch the selected feature circuits ON or OFF.

When finished, press the **Menu** button twice to return to the main screen.

Lights Menu

From the Lights screen you can manually switch all lights on or off, and synchronize colored lights. Up to eight (8) lights (EasyTouch 8) or 4 lights (EasyTouch 4) can be independently controlled from the **Lights** screen. Each light requires a separate auxiliary relay circuit. Up to four lights can be assigned on each auxiliary circuit. A circuit name must be assigned to the AUX relay circuits which controls the light. Verify that IntelliBrite, *SAm* and/or *SAL*, and/or *FIBERworks* have been selected in Circuit Function. If *FIBERworks* lighting is being used, it also has to be set up as a Photon Generator® (PHOTON GENERATOR) for the circuit controlling the light bulb, and COLOR WHEEL for the circuit controlling the color wheel. For more information about setting up lights, see “Settings Menu: Circuit Function,” on page 37.

The Color Swim and Color Set Lighting Features

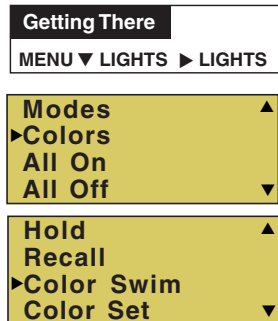

The Color Swim and Color Set lighting features is selected from the **LIGHTS > MODES** and (**COLORS**) menu. At least two (2) Pentair Water Pool and Spa® IntelliBrite®, *SAm*®, *SAL*® and/or *FIBERworks*® lighting systems are required to use the lighting features.

- **Color Swim** - Select the Color Swim feature in the **MODES** and **COLORS** menus to start lights to transition through colors in sequence to give the appearance of colors dancing through the water. You can adjust the delay of each light to make the colors move at different speeds using the **LIGHTS > CONFIG** option. This lighting feature requires a separate relay for each light. To switch off the Color Swim feature, select the AUX button assigned to the light circuit or select ALL OFF in the Lights menu.
- **Color Set** - Select the Color Set feature in the **MODES** and **COLORS** menus to switch the light on using specific color as selected in the **COLORS** menu. This feature requires a separate relay for each light. To switch off the Color Swim feature, select the AUX button assigned to the light circuit or select ALL OFF in the Lights menu.
- **Configure** - Select “Configure” to setup the positions of the lights the pool. Up to eight (8) lights can be assigned a position. For more information see page 20.

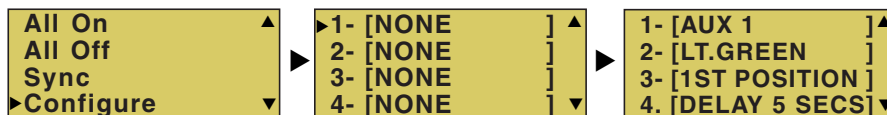

- **Sync** - Select the Sync feature in the **LIGHTS** menu to switch on all IntelliBrite, *SAm*, *SAL*, or *FIBERworks* color changing lights and synchronize their colors.
- **Smart Start** (SS: Yes/No) - Select Smart Start in the Schedules menu (see page 25). The Smart Start feature automatically starts changing colors when the lights are programmed to switch on. Smart Start is used when Color Swim and IntelliBrite show modes are being used.

Setting up Lights

The following section describes how to assign a light circuit name and function to control Pentair Water Pool and Spa IntelliBrite, *SAM* and/or *SAL*, and/or *FIBERworks* lights.

Assign the Light Circuit Name and Function

The first step in setting up a light circuit is to assign a name to the relay circuit (example; AUX 3, as “Pool Light”), then assign the name “Pool Light” circuit in the Circuit Func. menu as a “light” circuit (IntelliBrite, SAM, SAL..). The light circuit functions are: Light, SAM, SAL, Photon Generator, Color Wheel, Spillway, MagicStream and IntelliBrite (see page 38). After assigning the circuit name and function, the light circuit name “Pool Light” can be setup in the CONFIG menu for light position, color etc.

To assign a circuit function:

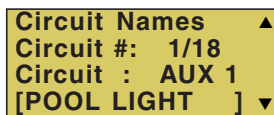

Up/Down buttons: Select the circuit number 1/18. Press the **Up button** two times to select AUX 1 to choose this circuit for a light circuit On/Off button. The generic circuits names are: Spa, Pool, Aux 1-7 (EasyTouch 8), Aux 1-3 (EasyTouch 4), FEATURE 1-8 (Ft. 1-8), AuxX (Aux Extra). The circuit number (1/18) corresponds to its assigned circuit name.

Right button: Select the EasyTouch preset circuit names and user defined custom circuit names.

Up/Down buttons: Scroll through the list of preset names (see page 36 for a complete list of circuit names). Select a name that describes where the light is located or that suits the function, such as “Pool Light.” AUX 1 has now been assigned the circuit name “Pool Light.” If you cannot find a name to match your circuit, you can create your own custom name (see page 36). Repeat this step for all the circuit buttons that you wish to assign names to. “Aux Extra” is only available if the Solar output (J17) plug on the EasyTouch motherboard is not being used for solar equipment. The **Down arrow button** is used to turn the “extra” circuit on and off.



Press the **Menu** button to return to the Settings menu. Press the Down button to and select “Circuit Func.” Press the **Right button** to access the Circuit Func. menu.

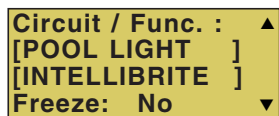

Up/Down buttons: Select the already assigned circuit name “Pool Light.”

Right button: View “Circuit Functions” to assign to light circuit “Pool Light.”

Up/Down buttons: Select the type of light circuit function to use. The circuit function names are: LIGHT, SAM LIGHT, SAL LIGHT, PHOTON GEN, COLOR WHEEL, VALVE, SPILLWAY, FLOOR CLEANER, INTELLIBRITE, MAGICSTREAM, GENERIC, and MSTR CLEANER. For a complete list of preset circuit functions, see “Preset Circuit Functions” on page 38.

Note: To use the “Color Swim” or “Color Set” feature, select IntelliBrite, SAM, SAL, Photon Generator or Color Wheel. Select “MagicStream” for MagicStream laminars.

Press the **Menu** button three times to return to the main screen.

Setting up lights

From the Lights screen you can manually switch all lights on or off, synchronize colored lights, and activate color light shows. Up to eight (EasyTouch 8) or four (EasyTouch 4) light circuits can be configured from the “Config” light menu. Each light must have its own relay and separate circuit.

Setting up IntelliBrite Light Circuits

Before configuring the lights, be sure the auxiliary (AUX) circuits that control the IntelliBrite lights have been assigned as an “IntelliBrite” light. For more information about “Circuit Functions” (page 37) and “Circuit Names,” (page 39).

Lights Menu

To access the Lights menu screen, press **Menu > Lights**. The Lights menu settings are: MODES, COLORS, ALL ON, ALL OFF, SYNC, MAGICSTREAM, CONFIG:



Modes (IntelliBrite Color light shows, Color Swim, Color Set)

To access the Modes menu, press **Menu > Lights > Modes**. There are six pre-programmed color light shows to choose from. From the “Modes” screen you can select various preset show color lighting effects, such as “American mode” and “Sunset mode”, “Color Swim” or “Color Set.” Using the “Hold” and “Recall” feature (see page 19) you can also capture and save a unique color light show effect to recall at a later time.

The IntelliBrite color “Mode” settings light shows are:

- **Party:** Rapid color changing building the energy and excitement
- **Romance:** Slow color transitions creating a mesmerizing and calming effect
- **Caribbean:** Transitions between a variety of blues and greens
- **American:** Patriotic red, white and blue transition
- **Sunset:** Dramatic transitions of orange, red and magenta tones
- **Royalty:** Richer, deeper, color tones

IntelliBrite Light: If the IntelliBrite light was not previously on, after selecting a color show mode, no illumination will occur for up to ten (10) seconds (depending on the selection), then a white light will momentarily illuminate, followed by the color show mode selection. If the light was previously on, selecting the a color show mode button will momentarily illuminate the previously selected color before changing to the selected color show.

Modes (Color Swim)

The Color Swim feature cycles through white, magenta, blue and green colors. Using IntelliBrite lights, Color Swim emulates the Pentair Water Pool and Spa SAM and SAL Color Swim feature.

IntelliBrite Light Color Swim/Color Set: If the light was not previously on, after selecting Color Swim, no illumination will occur for approximately six (6) seconds followed by the selection. If the light was previously on, after selecting the Color Swim feature, the previously selected color will momentarily illuminate, no illumination will occur for approximately six (6) seconds followed by the selection.

Setting up lights (Continued)

Modes (Color Set)

The “Color Set” feature allows any combination of up to eight (EasyTouch 8) or four (EasyTouch 4) IntelliBrite lights, and Pentair SAm, SAL and or Fiberworks lighting to be preset to specific colors. Fixed light colors are selected and activated from the Colors screen.

IntelliBrite Light: *If the light was not previously on, after selecting the fixed colored light, no illumination will occur for approximately six (6) seconds followed by the selection. If the light was previously on, after selecting the colored light, the previously selected color will momentarily illuminate, no illumination will occur for approximately six (6) seconds followed by the selection.*

Colors

Choose any one of the five fixed colors to create a spectacular underwater lighting effect. The fixed colors are: **Blue, Green, Red, White** and **Magenta**. You can switch each fixed colored light on or off from the Colors screen.

IntelliBrite Light: *If the light was not previously on, after selecting a fixed colored light, no illumination will occur for up to ten (10) seconds (depending on the selection), then a white light will momentarily illuminate, followed by the color selection. If the light was previously on, selecting the a color button will momentarily illuminate the previously selected color before changing to the selected color.*

To select a fixed color press: **Menu > Lights > Modes > Colors:**

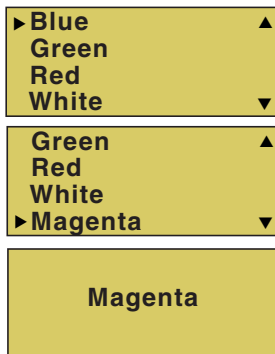

Up/Down buttons: Choose a color for the light.

Right button: Switch the selected colored light ON. To switch the light off, go to the main Lights menu and select **All Off**, or press the AUX button assigned to the light. The AUX button will also switch the light on.

Press the **Menu** button three times to return main menu.

⚠ WARNING - IntelliBrite Lights: During the off/on switching process, before the selected color is displayed, no illumination will occur. This operating mode is normal during the switching process. During this period the pool and spa will be dark and precautions should be taken to avoid unforeseen accidents. Failure to observe this warning may result in serious injury or death to pool and spa users.

Hold/Recall

Select Hold and Recall from the “Modes” or “Color” screen to capture and save a unique color effect and recall it at a later time. For example, while a light show (Romance Mode) is active, select “Hold” to save the exact colors that are being displayed, then later, to recall the exact color effect, select “Recall.”

Note: *After selecting Hold or Recall, no illumination will occur for up to 10 seconds, then a white light will momentarily illuminate, followed by the saved color.*

All On / All Off (Lights Menu)

Select **All On** or **All Off** from the Lights screen to manually switch all lights on or off, including any MagicStream laminar circuits. Press the control panel auxiliary button (AuxX) assigned to a light circuit will also switch a light on or off.

Sync

Select **Sync** from the “Lights” screen to synchronize colors for all IntelliBrite, SAm, SAL, and FIBERworks color changing lights.

Setting up lights (Continued)

Config

From the “Config” screen you can setup the IntelliBrite light position, and specify the color of each pool and spa light. Any combination of up to eight (EasyTouch 8) or four (EasyTouch 4) IntelliBrite lights, Pentair SAM, SAL and or Fiberworks lights can be preset for specific colors and position when using the “Color Swim” and “Color Set” feature. Fixed light color are selected and activated from the Colors screen. *Note: The “Config” menu settings do not apply to the MagicStream laminars.*

To select configure a light position and color: **Menu > Lights > Config:**

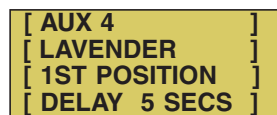
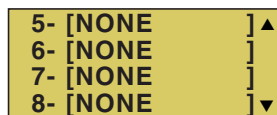

Up/Down buttons: Choose the light circuit (1-8) to configure. Select an available auxiliary circuit (NONE). For more about assigning an auxiliary circuit to a light, see “Circuit Functions (page 37) and “Circuit Names” (page 39). EasyTouch 8 supports up to eight (8) auxiliary circuits, EasyTouch 4 supports up to four (4) auxiliary circuits.

Right button: Select the light to setup.

Up/Down buttons: Select the light circuit.

Right button: Move to the light color selection.

Up/Down buttons: Select the light color (**Blue, Cyan, Green, Lt. Green, White, Lt. Magenta, Magenta, Lavender**).

Right button: Move to the light position selection.

Up/Down buttons: Select the light position. A light can be assigned to any position from 1 through 12. To ensure that the “Color Swim” and “Color Set” lighting feature color effects are correct, set the position of the light according to where it’s located in the pool or spa. **Position 1** will lead all the other lights in the color changing sequence. **Position 2** follows Position 1 and so on. There are 12 position to choose from. More than one light may be assigned to the same position number so that their colors may be synchronized. For example, to make the colors swim right to left, make your right most light Position 1. You may need to go back to and scroll through your lights to find the right most light, and set it as Position 1.

Right button: Move to the light delay selection. The Delay time between two or more lights can be set from 0 to 60 seconds. Use a higher delay time for lights spread further apart. Try five seconds for all lights and observe the effect. Use different time settings to achieve unique lighting moods and effects.

Press the **Menu** button to setup other lights or press Menu button four times to return main screen.

Setting up SAM, SAL, PG2000, Color Wheel Lights

Before using the lighting feature “Color Swim” or “Color Set” with Pentair SAM or SAL lights, make sure the AUX relay circuits which control the lights have been assigned as “light” circuit and that the name (AUX 1, AUX 2) has been changed to best fit the light being used. Verify that *SAM* and/or *SAL*, and/or *FIBERworks* have been assigned in “Circuit Functions” as SAM or SAL light. If *FIBERworks* lighting is incorporated, it also has to be set up as a “PHOTON GENERATOR” light for the circuit controlling the light bulb, and COLOR WHEEL for the circuit controlling the color wheel it self. The circuit light “functions” are: Light, SAM, SAL, Photon Generator, Color Wheel, and IntelliBrite, see page 38 for a more information.

Setting up MagicStream Laminars

The MagicStream® Laminar provide a clear, turbulence-free stream of water that is lit with a fiber optic cable, or an LED light for a dazzling nighttime effect. The 12 VAC powered LED light can generate a series of multicolored light shows, or can be set to display a continuous, single color. If desired, the built-in solenoid “thumper” can create a random “wrinkle,” in the Laminar’s stream, causing it to display a brilliant spot of light that moves along the stream’s arc. The light enhancer can be adjusted to maximize the light in the arc.

Up to twelve (12) MagicStream Laminar circuits can be displayed on the main Lights screen, assuming each laminar has its own relay and separate circuit.. From the Lights screen you can activate the MagicStream laminars (changing color modes, turn Thumper on/off, Hold and Reset). For more information, see the MagicStream Installation Guide, P/N 520969.

Setting up MagicStream Laminar LED Lights

To setup MagicStream laminar circuits, first assign each laminar auxiliary relay circuit a circuit name (see “Circuit Names” page 39, then assigned the laminar relay circuit name to “MAGICSTREAM” in the circuit functions menu (Circuit Func.).

To setup the MagicStream laminar circuit names and function:

Getting There
MENU ▼ SETTINGS ▼ CIRCUIT NAMES ►

IntelliFlo ▲
IntelliChlor ▲
►Circuit Names
Circuit Func. ▼

Up/Down buttons: Select the circuit number 1/18. Press the **Up button** two times to select AUX 1 to choose this circuit for the MagicStream circuit On/Off button. The generic circuits names are: Spa, Pool, Aux 1-7 (EasyTouch 8), Aux 1-3 (EasyTouch 4), FEATURE 1-8 (Ft. 1-8), AuxX (Aux Extra).

Circuit Names ▲
Circuit #: 1/18
Circuit : AUX 1
[STREAM] ▼

The circuit number (1/18) corresponds to its assigned circuit name.

Right button: Select the EasyTouch preset circuit names and user defined custom circuit names.

Up/Down buttons: Scroll through the list of preset names (see page 36 for a complete list of circuit names). Select a name that describes where the MagicStream laminar is located or that suits the function, such as “Stream.” AUX 1 has now been assigned the circuit name “Stream.” for the first MagicStream laminar. Repeat this step for the next laminar circuit. If you cannot find a name to match your circuit, you can create your own custom name (see page 36). “Aux Extra” is only available if the Solar output (J17) plug on the EasyTouch motherboard is not being used for solar equipment. The **Down arrow button** is used to turn the “extra” circuit on and off.

Getting There
MENU ▼ SETTINGS ▼ CIRCUIT FUNC. ►

Press the **Menu** button to return to the Settings menu. Press the Down button to and select “Circuit Func.” Press the **Right button** to access the Circuit Func. menu.

Circuit / Func. : ▲
[STREAM]
[MAGICSTREAM]
Freeze: Yes ▼

Up/Down buttons: Select the already assigned circuit name “Stream.”

Right button: View the “Circuit Functions” to assign to laminar circuit “Stream.”

Up/Down buttons: Select the type of circuit function to use, in this case select “MAGICSTREAM.” The circuit function names are: LIGHT, SAM LIGHT, SAL LIGHT, PHOTON GEN, COLOR WHEEL, VALVE, SPILLWAY, FLOOR CLEANER, INITELLIBRITE, MAGICSTREAM, GENERIC, and MSTR CLEANER. For a complete list of preset circuit functions, see “Preset Circuit Functions” on page 38.

Right button/ Up Button: Turn “Freeze” protection ON.

Press the **Menu** button three times to return to the main screen. *Continue on next page...*

Using the MagicStream Laminar Features

The MagicStream laminar features are displayed in the MagicStream menu. Each time a MagicStream feature is activated, MagicStream resumes with the same features in operation as when last switched off. The MagicStream features are as follows:

Toggle Thumper - Pressing this button creates a "wrinkle" in the laminar stream, producing a brilliant spot of light in the laminar arc.

Hold - Select Hold to capture the current color effect while colors are changing. The colors will stop changing. Selecting Hold again will resume the color changing mode.

Reset - Pressing this button reverts to the **Random** color changing mode with the Thumper ON.

Change Mode - Pressing this button (each successive OFF/ON combination) will cycle through **Sync**, **Random** and **Party**. Color changing mode - The color of the light changes automatically, according to one the following three programs:

Sync - Colors will change at ten second intervals. In this mode, multiple laminars will synchronize colors together. Note: To sync multiple laminars (two or more AUX circuits), be sure to define the "MagicStream" circuits in the "Circuit Functions" menu.

Random - Colors will change at ten (10) second intervals in a random sequence. In this mode, multiple laminars will NOT synchronize colors together.

Party - Colors will change randomly and slowly at first, then speed up, until the sequence ends with quick flashes and strobos. The sequence then repeats, beginning with the slow changes. In this mode, multiple Laminars will NOT synchronize colors together.

To access the MagicStream laminar features:

Getting There									
MENU ▼ LIGHTS ► LIGHTS									
<table border="1"> <tr><td>All On</td><td>▲</td></tr> <tr><td>All Off</td><td></td></tr> <tr><td>Sync</td><td></td></tr> <tr><td>►MagicStream</td><td>▼</td></tr> </table>	All On	▲	All Off		Sync		►MagicStream	▼	<p>Down button: Choose MagicStream.</p> <p>Right button: Select MagicStream.</p> <p>Up/Down button: Select the desired MagicStream features.</p>
All On	▲								
All Off									
Sync									
►MagicStream	▼								
<table border="1"> <tr><td>Toggle Thumper</td><td>▲</td></tr> <tr><td>Hold</td><td></td></tr> <tr><td>Reset</td><td></td></tr> <tr><td>►Change Mode</td><td>▼</td></tr> </table>	Toggle Thumper	▲	Hold		Reset		►Change Mode	▼	<p>Right button: Use this button to activate the selected MagicStream feature. After the button is pressed, the following screen displays the name of the selected feature (indicating that the MagicStream feature has been activated) then returns to the MagicStream feature menu.</p>
Toggle Thumper	▲								
Hold									
Reset									
►Change Mode	▼								
<table border="1"> <tr><td>Change Mode</td></tr> </table>	Change Mode	<p>Press the Menu button three times to return to the main screen.</p>							
Change Mode									

Heat Menu

Use the heat menu settings to specify the set point temperature and select the heat source for the pool and spa water. The water will begin to heat whenever the heater is manually switched on, (by pressing the Valves (V) button (on the Outdoor Control Panel) or the “Pool” or “Spa” button on the Indoor Control Panel), even if the heater is set to off. The spa will also begin to heat when switched on by the optional iS4/iS10 Spa-Side remote, or EasyTouch wireless remote. The EasyTouch system allows for solar and conventional heaters. The EasyTouch will use the heating source that is selected. The heat source selections are:

- **OFF** - No heating even though pump and other circuits may be operating.
- **HEATER** - Gas heater only. Use the Heater button to automatically switch the heater on which controls the output between a “forced off” state and a normal, automatic thermostatic control operating state. The heater will continue heating the water until the heater’s current highest set point temperature triggers the heater sensor (approximately 104° F or 40° C). Note that the Heater button on the control panel does not activate the pump. Do not activate the heater without running the pump. The heater will not run if water flow is not detected.
- **SOLAR ONLY** - Solar heating system to be the only heat source. In order to display “Solar Pref.” on the main screen, you must first enable solar in the “Solar” menu (see page 40).
- **SOLAR PREF. (Solar Preferred)** - Solar and gas heating systems are installed, and you want to use solar heating only when it is most effective. In order to display “Solar Pref.” on the main screen, you must first enable solar in the “Solar” menu. To set the spa temperature and select the heat source:

Pool Temp/Src

Getting There

MENU ▼ HEAT

To set the pool temperature and select the heat source:

► POOL Temp/Src ▲
SPA Temp/Src ▼

Right button: Select pool temperature and heater options.

Up/Down button: Set the pool temperature (from 40° F to 104° F).

Right or Left button: Move to Heater option.

POOL ▲
Temp: 72° F
Heat: Off ▼

Up/Down: Set Heater option: **Off, Heater, Solar, or Solar Preferred.**

Press the **Menu** button to save the settings and to return to the previous menu or press the button again to return to the main screen.

Spa Temp/Src

To set the spa temperature and select the heat source:

► POOL Temp/Src ▲
SPA Temp/Src ▼

Right button: Select spa temperature and heater options.

Up/Down button: Set the spa temperature (from 40° F to 104° F or 4° C to 40° C).

Right or Left button: Move to Heater option.

SPA ▲
Temp: 85° F
Heat: Off ▼

Up/Down: Set Heater option: **Off, Heater, Solar, or Solar Preferred.**

Press the **Menu** button to save the settings and to return to the Heat menu or press the button again to return to the main screen.

Note: For an EasyTouch single body system, “Pool” and “Spa” modes are Lo-Temp (Pool) and Hi-Temp (Spa) temperature controls. For more information, see “Hi-Temp/Lo-Temp Controls for Single Body Systems,” on page 35.

Delay Cancel Menu

Use the Delay Cancel feature for service or testing purposes. For convenience, on a onetime basis, the Delay Cancel feature will cancel the following safety delays. Please note, generally there is no need to cancel any of the following delays except for servicing or testing the system.

- **Heater Cool-Down Delay Cancel:** Shuts Filter Pump off immediately.
- **2-Speed Filter Pump five-minute START on HIGH SPEED Delay Cancel:** Shifts pump to low speed.
- **Automatic Pool Cleaner START Delay:** Starts Cleaner Pump immediately, without normal delay in which the filter pump first runs for 5 minutes.
- **Automatic Pool Cleaner SOLAR Delay:** Allows Cleaner Pump to run even though solar delay has shut it off for 5 minutes.

Some heaters require a cool-down cycle before being switched off. This can be setup in the menu to run the filter pump an additional ten minutes to dissipate residual heat built up inside the heater combustion chamber. The Delay Cancel feature is mainly for use by service technicians when it's necessary to shut the filter pump off immediately, and know the heater has not been running. Heaters manufactured by Pentair Water Pool and Spa do not require this cool-down period and do not need the delay to be set up.

Note: For Information about assigning delays to the pool and spa valves, refer to “Settings Menu: Delays” on page 41.



Delay Cancel

To activate Delay Cancel:

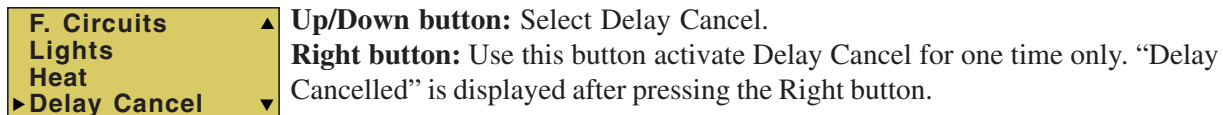

Press the **Menu** button to return to the main screen.

Schedules Menu

Use the Schedules menu to create programs to schedule start and stop times to automatically run equipment, such as pumps and lights. Any circuit can be programmed to switch on and off at a specific time on every or any specific day of the week. The number of programs that can be created for circuits are as follows:

- Up to 12 total programs can be created for all circuits combined.
- One circuit can have up to a maximum of 9 programs (9/9), which leaves 3 programs that can be used by one circuit or three separate circuits for a total of 12 programs.

Using the Schedules menu

Use the Schedules menu features to program operating schedules for the pool, spa and auxiliary circuits:



▶ SPA	0	▲
POOL	0	
AUX 1	0	
AUX 2	0	▼

Choose the circuit to program

Up/Down button: Select the generic circuit name to program: Spa, Pool, Aux 1-7, Feature 1- 8, Aux 1-3 and Aux Extra. Aux Extra is only available if the Solar output is not being used. See Solar button on page 5 for details.

The current number of programs for each circuit is displayed opposite the circuit name. A circuit can have up to 9 programs (9/9). Three additional programs can be assigned to another circuit or three separate circuits for a maximum of 12 programs.

SPA	0/0	▲
Mode: None		

Create a new program

The current number of programs for each circuit is indicated opposite to the circuit name. 0/0 indicates no programs assigned to this circuit.

Right button: To move to the “Mode” selection.

SPA	0/0	▲
Mode: New		▼

Up/Down button: Select **New** to create a new program. Use “None” when a circuit has existing programs and you wish to exit the “Mode” selections without modifying the existing programs.

SPA	1/1	▲
Mode: Schedule		
08:00A - 05:00P		
smtwtfs SS: N		▼

Choose the type (Mode) of program to run

After selecting “New” the current program number (1/1) for this circuit is displayed.

Right button: To move to the “Mode” selections.

SPA	1/1	▲
Mode: Egg Timer		
Timer: 12:00		▼

Up/Down button: Choose the program to run: **Schedule, Egg Timer, Once Only, New, Delete, and None**. If there are existing programs assigned to this circuit, use these buttons to view and select the existing program settings.

Mode Selection:

SPA	1/1	▲
Mode: Once Only		
08:00A		
smtwtfs		▼

Schedule: Set start, stop times and the day(s) of the week to automatically switch pool/spa circuits on or off. Default run time for the “Schedule” feature is 8:00 AM to 5:00 PM. If you program the start and stop times the same the schedule is will run for 24 hours. *Note: SS: N (Smart Start) is displayed if a light circuit is being scheduled (see page 16).*

SPA	1/1	▲
Mode: New		▼

Egg Timer: A one time program that switches on a function at a specific time, and counts down the preset time to the switch off the function. After the “Egg Timer” schedule has finished, the system can be operated in manual mode. The “DON'T STOP” option allows a circuit to run continuously until its switched off manually.

SPA	1/1	▲
Mode: None		▼

Once Only: Schedule a circuit to switch on at a particular time on a onetime basis.

New: press the **Right** button to create a new program.

SPA	1/1	▲
Mode: Delete		▼

Delete: Select the program and press the **Right** button to delete it.

None: Press the **Right** button to exit the “Mode” selections without modifying the program.

Schedules Menu (Continued)

Schedule your spa/pool pump to turn on

Use the Schedule feature to set the time and day(s) when to switch the filter pump on and rotate the pool or spa valves into the “Spa” or “Pool” position. The heater will automatically heat the spa or pool water up to the set point temperature as set in the “Heat” menu (see page 23). If the pool has a separate jet pump or blower controlled by AUX 1 and/or AUX 2 , these need to be scheduled separately.

Schedule Example

When a circuit relay is switched on manually, it remains on until you either switch it off manually, or the next time the relay is scheduled to be switched off. For example, if the filter pump or any circuit is scheduled to run from 9AM to 4 PM and the programmed schedule is turned OFF at 1:00 PM and then turned on at 1:10 PM, the circuit will turn OFF at its programmed OFF time of 4:00 PM. But if the circuit is turned on after 4:00 PM, the factory set Egg Timer of 12 hours is now engaged. So if the circuit was turned on at 6:00 PM that circuit will turn off at 6:00 AM (12 hours later). If the circuit was turned ON at 5:00 PM and because a programmed OFF time had been set to turn off at 4:00 PM, the circuit would operate for 11 hours. A spa or pool program can be overridden using the Spa button or Pool button to switch the circuit on. If you program the start and stop times the same, the schedule will run for 24 hours if scheduled to run for one day. In “Service” mode, a pool or spa program can be overridden using the Filter (F) button and pool/spa Valves (V) button on the outdoor control panel in the EasyTouch load center. **Note:** *The following example describes how to use the “Schedule” feature to program the spa circuit to switch the filter pump on and rotate the valves into the “Spa” position and switch the heater on. This example can also be used to program when to filter and heat your pool, and switch light or auxiliary circuits on or off.*

To create a schedule for your spa or pool pump to turn on:

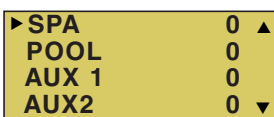
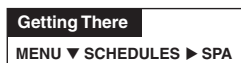

Right button: Select the **SPA or POOL** circuit. The available generic circuit names are: Spa, Pool, Aux 1-7 (EasyTouch 8), Aux 1-3 (EasyTouch 4), Feature Circuit 1-8 and Aux Extra. Aux Extra is only available if the Solar output (J17) plug on the EasyTouch motherboard is not being used for solar equipment. Use the Solar button to switch the “extra” circuit on and off (see page 4).

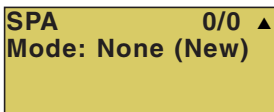

Right button: Select **Mode** if there are existing programs. Skip this step to create a new program.

Up/Down button: Select **New** to create a new program.

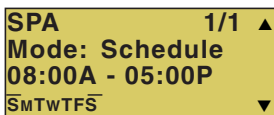

Right button: To create a new program and enter the “Mode” settings.

Up/Down button: 1/1 indicates that this circuit has one program. If there are existing programs assigned to this circuit, use these buttons to view and select the existing program settings.

Right button: To select the “Schedule” settings.

Right button: Move to start and stop time settings.

Up/Down and Right buttons: Set start and stop hour (A/P), minutes.

The A (AM) and P (PM) time is set when setting the start and stop hour.

Right button: Move to days of the week to run the program.

Right and Up/Down buttons: By default the program is set to run all the days of the week. If you wish to edit which days to run the program, select the day of the week, then press the **Up/Down** button to remove the bar from the top of the letter. A bar on top of the letter indicates the day selected to run the program.

Press the **Menu** button to save the settings and to return to the Schedules menu options. Press the button again to return to the main menu options or press again to return to the main screen.

Using the Once Only feature

The “Once Only” feature allows you to program a circuit to switch on at a particular time and day on a onetime basis. A typical use for this feature is to have the spa and heater switch on before you get home from work for one evening. Unlike the regular “Schedule” timer, this feature does not repeat. After this event has finished, the program is automatically erased. The circuit must be switched off manually or wait for the 12 hour automatic shut off. If you wish to override the 12 hour default shut-off time you can extend the time by using the “Egg Timer” countdown feature (page 28).

Note: The following example describes how use the “Once Only” feature to program the spa circuit to switch the filter pump on and rotate the valves into the “Spa” position and switch the heater on for one time only. This example can also be used if you wanted to program when to filter and heat your pool, and switch light or auxiliary circuits on.

The set a “Once Only Timer” program for the spa:

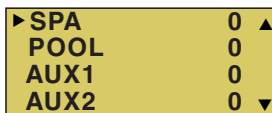
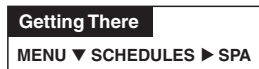

Right button: Select the **Spa** circuit. The generic circuit names are: Spa, Pool, Aux 1-7 (EasyTouch 8), Aux 1-3 (EasyTouch 4), Feature Circuit 1-8, and Aux Extra. Aux Extra is only available if the Solar output (J17) plug on the EasyTouch motherboard is not being used for solar equipment. Use the Solar button to switch the “extra” auxiliary circuit on and off (see page 4).

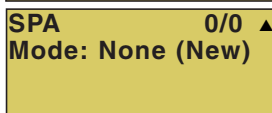

Right button: Select **Mode** if there are existing programs. Skip this step to create a new program.

Up/Down button: Select **New** to create a new program.

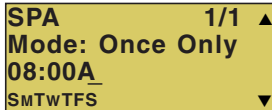

Right button: To create a new program and enter the “Mode” settings.

Up/Down button: 1/1 indicates that this circuit has one program. If there are existing programs assigned to this circuit, use these buttons to view and select the existing program settings.

Right button: To select the “Once Only” settings.

Right button: Move to start time settings.

Up/Down and Right buttons: Set the start hour (A/P) and minutes. A (AM) and P (PM) time is set when setting the start hour. Note: if the Start Time is set to an hour which has already passed, then the program will be executed the following day. Another day of the week may also be chosen. The stop time will be 12 hours later, or can be turned off manually. The 12-hour shut off can be changed to any length of time by entering another program using the “Egg Timer” program (page 28).

Right button: Move to day of the week to run the program.

Right button: Select which day to run the program then press the **Up/Down button** to enable the bar on top of the letter. A bar on top of the letter indicates the day selected to run the program.

Press the **Menu** button to save the settings and to return to the Schedules menu options. Press the button again to return to the main menu options or press again to return to the main screen.

Using the Egg Timer (countdown) Feature

The “Egg Timer” feature allows you switch off a circuit automatically after a specified time. The time period is from one minute to 24 hours or run continuously. The “Egg Timer” (countdown) feature is useful for switching off lighting and spa therapy jets. For example, a jet pump can be setup to switch off in 15 minutes, even if you switch it on using the iS4 or iS10 Spa-Side remote control or whenever you switch your spa on, you would like it to automatically switch it off in two hours. All Egg Timer programs are factory set to switch off after 12 hours. You also have the option to use the “Don’t Stop” feature to run a circuit continuously until manually switched off.

In the event of a power failure, the “Egg Timer” feature will not switch the circuit back on. Use the “Service” Mode button on the EasyTouch outdoor control panel to turn the equipment back on. For running the filter pump continuously during new pool start up, it is recommended to use the “Service” mode, which will automatically restart the filter pump in the event of a power failure.

The following example describes how use the “Once Only” feature to program the spa circuit to switch the filter pump on and rotate the valves into the “Spa” position and switch the heater on for one time only. This example can also be used if you wanted to program when to filter and heat your pool, and switch light or auxiliary circuits on.

To set the Egg Timer feature:

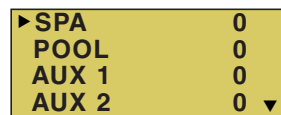
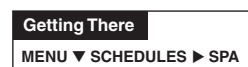

Right button: Select the **Spa** circuit. The generic circuit names are: Spa, Pool, Aux 1-7, (EasyTouch 8), Aux 1-3, (EasyTouch 4), Feature Circuit 1-8 and Aux Extra. Aux Extra is only available if the Solar output (J17) plug on the EasyTouch motherboard is not being used for solar equipment. Use the Solar button to switch the “extra” auxiliary circuit on and off (see page 4).

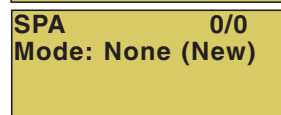

Right button: Select **Mode** if there are existing programs. Skip this step to create a new program.

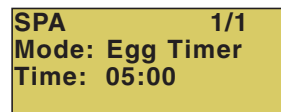

Up/Down button: Select **New** to create a new program.

Right button: To create a new program and enter the “Mode” settings.

Up/Down button: 1/1 indicates that this circuit has one program. If there are existing programs assigned to this circuit, use these buttons to view and select the existing program settings.

Right button: To select the “Egg Timer” settings.

Right button: Move to the time settings.

Up/Down and Right buttons: Set the hour and minutes for the program to run. The count down time can be set from 00:01 to 23:59 and Don’t Stop. The “Don’t Stop” feature allows the circuit to run continuously until manually switched off.

Press the **Menu** button to save the settings and to return to the Schedules menu options. Press the button again to return to the main menu options or press again to return to the main screen.

Settings Menu: Clock

Use the Clock menu to set the EasyTouch system date and time. The day, time and AM/PM is displayed on the main screen. The system clock settings are used for the EasyTouch system scheduled operations. The EasyTouch system clock will continue to run if power is removed from the EasyTouch system at the load center.

Getting There

MENU ▼ SETTINGS ► CLOCK

Clock

To set the system date and time:

Date & Time	1/2
JAN 12 2009	▲
09:20 AM	▼

Right button: Move to the day setting.

Up/Down buttons: Set the day of the month.

Right button: Move to the year setting.

Up/Down buttons: Set the year.

Date & Time	2/2
DayLt Sav: Auto	▲
Clk Adj: 00:00	▼

Right button: Move to the next set of settings (2/2).

Up/Down buttons: Set Daylight Savings to Auto or Manual. Auto keep track of the semi annual time changes. If you do not live in an area that observes daylight savings time, choose Manual.

Right button: Move to the clock adjustment setting. If the internal system clock loses time during the month, use this setting to set the number of seconds in five second increments per month to automatically adjust the clock to the correct time.

Up/Down buttons: Adjust the offset in five second increments.

Press the **Menu** button to save the settings and to return to the Settings menu options. Press the button again to return to the main menu options or press again to return to the main screen.

Settings Menu: IntelliFlo

The EasyTouch system communicates with the IntelliFlo pump via a two-wire RS-485 cable (PN 350122). For more information about the IntelliFlo pump see the IntelliFlo VS Installation and User's Guide (P/N 357269), for the IntelliFlo VF pump, see the IntelliFlo VF Installation and User's Guide (P/N 350075). From the IntelliFlo menu setting the following pumps can be programmed to run at specific U.S. gallons per minute (GPM) or speed (RPM):

- The IntelliFlo VF (15-130 GPM) and IntelliPro VF (15-130 GPM)
- The IntelliFlo VS+ SVRS (1100-3450 RPM), IntelliFlo VS3050 (400-3110 RPM) and IntelliPro VS3050 (400-3450 RPM)

How many IntelliFlo pumps will EasyTouch support?

EasyTouch can support a total of two IntelliFlo VF or IntelliFlo VS pumps in any combination with up to eight GPMs or RPMs per pump. For example pumps can be connected to EasyTouch as follows:

- 1 IntelliFlo VF + 1 IntelliFlo VS
- 2 IntelliFlo VF
- 2 IntelliFlo VS

IntelliFlo

To access the IntelliFlo VS menu:

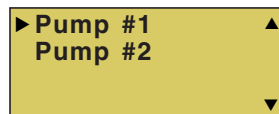

Up or Down button: Choose Pump #1 or Pump #2

Right button: Select Pump #1 to assign as IntelliFlo VF or IntelliFlo VS.

Right button: Select Pump Type.

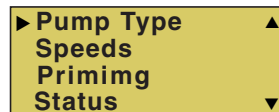

Up/Down buttons: Choose **VS** or **VF**. Select VS (IntelliFlo VS).

Menu button: Press the menu button to save selection and go to the IntelliFlo VS menu settings.

Down button: Choose **Speeds**.

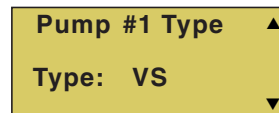

Right button: Access the IntelliFlo VS settings for Pump #1.

Up/Down button: Select the circuit number 1 of 8 (1/8). The default speed for each circuit correspond to the four speed buttons on the IntelliFlo VS control panel. The preset speed for each button is: Speed 1 button 750 RPM, Speed 2 button 1500 RPM, Speed 3 button 2350 RPM, and Speed 4 button 3110 RPM.

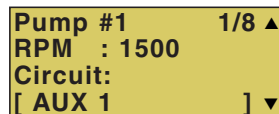

Right button: Move to RPM to change the pump speed.

Up/Down buttons: Set speed of the pump from 400 to 3110 RPM in increments of 10 RPM (For the IntelliFlo VS 3050) 400-3450 RPM (IntelliPro VS 3050).

Right button: Move to the circuit names.

Up/Down buttons: Assign the circuit: None, Spa, Pool, Aux 1-7, Feature 1-8 (EasyTouch 8), Aux 1-3 (EasyTouch 4), Feature Circuits 1-8, Aux Extra (only if Solar is not selected, see page 40), Heater, Pool Heater, Spa Heater, Freeze, and Hi-Speed. "Aux Extra" is only available if the Solar output (J17) plug on the EasyTouch motherboard is not being used for solar equipment.

Right button: Press the Up arrow button and go to the next circuit page settings (2/8) and repeat the previous steps.

iS4/iS10 pump speed control: IntelliFlo pump speed can be increased or decreased in increments from an iS4 or iS10 spa-side remote. See "iSx Pump Control" in the "Settings" menu (page 44).

When finished setting up the circuits, press the **Menu** button to save the settings and to return to the Settings menu options. Press the button two times to return to the main screen.

IntelliFlo VF

To access the IntelliFlo VF menu:

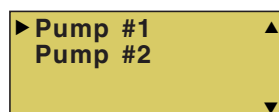

Up or Down button: Choose Pump #1 or Pump #2

Right button: Select Pump #1 to assign as IntelliFlo VF or IntelliFlo VS.

Right button: Select Pump Type.

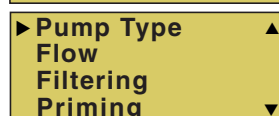

Up/Down buttons: Choose **VS** or **VF**. Select VF (IntelliFlo VF).

Menu button: Press the menu button to save selection and go to the IntelliFlo VS menu settings.

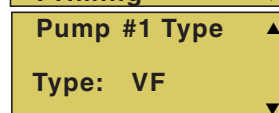

Down button: Choose **Flows**.

Right button: Access the IntelliFlo VF flow settings.

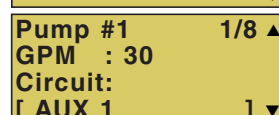

Up/Down buttons: Assign the circuit: None, Spa, Pool, Aux 1-7 (ET8), Aux 1-3 (ET4), Feature 1-8, Aux Extra (only if Solar is not selected, see page 25 and 42), Heater, Pool Heater, Spa Heater, Freeze, and Hi-Speed. “Aux Extra” is only available if the Solar output (J17) plug on the EasyTouch motherboard is not being used for solar equipment.

Right button: Press the Up arrow button and go to the next circuit page settings (2/8) and repeat the previous steps.

When finished setting up a parameter, press the **Menu** button to save the settings and to return to the IntelliFlo VF setting menu. When finished setting up all of the IntelliFlo VF pump parameters, press the **Menu** button until the main screen displays.

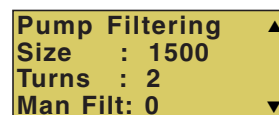

iS4/iS10 pump speed control: IntelliFlo pump speed can be increased or decreased in increments from an iS4 or iS10 spa-side remote. See “iSx Pump Control” in the “Settings” menu (page 44).

Description	Value
Pool Size/Gallons The pool size value is expressed as 1000's of gallons (Kgal). Enter from 1 to 1000 Kgal for the pool volume. The volume number can be a close estimate, although the more accurate the better the turns will be done when employing filter mode. Filter mode uses this value in coordination with the parameters from Filter mode to sustain turn rates, flows, and times.	0-255
Turnovers per day You can set up to up to eight turns per day. It is recommended to set one turn per day for energy conservation for most common residential pools. Also, refer to your sanitizer recommendation for additional information.	1-8
Manual Filter GPM (Default is 30 GPM) Manual Filter sets the flow at which the pump will run if it is turned on manually. The IntelliFlo pump will only run in the 'Filter' mode during the programmed times. For example, if the pump is programmed (start/stop times) for the pool circuit to run from 8:00 AM to 4:00 PM everyday. This program or programs are used by IntelliFlo to calculate at what speed it must run given those 'ON' times to achieve the turnover(s) for that sized pool for the basic filter mode.	15-130

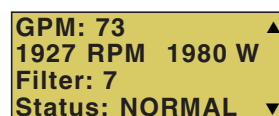

The Status screen is shown on the left.

Pump Priming	▲
Max Flow : 55	
Max Time : 5	
Sys time : 0	▼

Description	Value
Max Prime Flow GPM - (Default is 55 GPM) Every time the pump starts this parameter will negotiate the maximum flow of the pump. If the flow is too high, equipment damage can occur. If the flow is too low the pump will not prime. This "flow" is system dependent and may require adjustment. The pump will never flow more than this parameter is set to, however, it is common for the pump to ramp up and down quickly while priming. Always try to keep this flow as low as possible for cost savings and safety.	15-130 GPM
Max Prime Time - (Default is 15 min.) Use this parameter to set the time that you want IntelliFlo try and prime before it reports an error. Remember that the IntelliFlo will attain prime every time it starts and goes through this cycle. The IntelliFlo mechanical seal can withstand about 15 minutes before severe damage occurs. The lower the time the quicker you will get a priming error if the system is difficult to prime. A well plumbed pool without having the strainer removed should prime in less than 30 seconds. If the strainer has been removed for cleaning and a substantial amount of air is in the system it should prime in about 60 to 90 seconds on the average, however, all systems will be different.	1-15 minutes
System Prime Time - (Default is 0 min.) Remember that the average unit will prime in a short period of time because the IntelliFlo has the ability to monitor itself to make sure it is primed. "System Prime Time" is for systems that require high flows that priming flow can provide but it is deemed that more time is needed to fully relieve all the air. The builder can program a pre determined amount of time, up to 5 minutes, to aid in relieving the air from difficult filters or complex vertical plumbing. The "System PrimeTime" should only be used where large air traps become problems within the system. The display will inform the user when this is engaged and when it is finished during the priming cycle at each start up cycle.	0-5 minutes

Backwash	▲
Clean Filt : 10	
Flow GPM : 60	
Duration : 5	▼

Description	Value
Clean Filter PSI - (Default is 14 PSI) The average PSI setting is between 10 PSI and 20 PSI for most pools and filters. The entered PSI value splits the percentage meter for the filter. When the "clean filter" value is reached, EasyTouch displays an alert message and the pump stops monitoring flow rates and starts managing pressure. The value represents the change in pressure over time from start up (system clean) to present day (system getting dirty). The changes can come from anywhere in the system, for example clogged skimmers or pots in pumps. Setting this parameter at a lower level will cause the alert message to come up sooner and you will have to clean your filter (cartridge) or backwash your filter (sand or DE) sooner.	1-50 PSI
Backwash Flow GPM - (Default is 60 PSI)	15-130 GPM
Backwash Duration - (Default is 5 minutes)	1-60 minutes
Rinse Time - (Default is 1minute)	1-60 minutes

Pump Vacuum	▲
Flow (gpm) : 50	
Time (min) : 10	▼

Description	Value
Vacuum Flow GPM (default is 50 GPM) This setting sets the GPM that the pool vacuum will use.	15-130 GPM
Vacuum Time Mins. (Default is 10 minutes) This parameter can be set from 1 to 600 minutes. The typical setting is 10 minutes. This setting sets the amount of time you wish to run the pool vacuum.	1-600 minutes (10 hours)

Settings Menu: IntelliChlor

While the EasyTouch system is in normal operating mode (“Pool,” “Spa” mode or “Spa Fill (Spillway),” it will control the IntelliChlor chlorine output level. The amount of chlorine introduced into the pool is determined by the amount of salt in the water, water temperature, and the amount of time the pool pump is running in “Pool” mode. Note: While in “Freeze Protection” mode, IntelliChlor will not operate or produce chlorine during the time that the filter pump is operating. For more information, refer to the IntelliChlor Electronic Chlorine Generator User’s Guide (P/N 520589).

IntelliChlor



To setup the IntelliChlor :

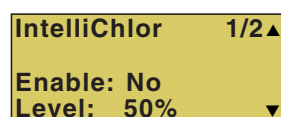

Right button: Enable/Disable IntelliChlor. (To select SuperChlor, run hours, press the Up/Down button - 2/2).

Up/Down buttons: Select **Yes** or **No** to enable or disable IntelliChlor.

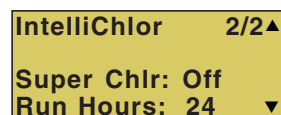

Right button: POOL Mode “50%” setting.

Up/Down buttons: Set the chlorination output level for the pool water from 0 to 100%. EasyTouch will determine the chlorinator output level when the system is operating in “Spa” or “Pool” mode. The amount of chlorine introduced into the pool/sap is determined by the amount of salt in the water, water temperature, and the amount of time the pool/spa operates in these modes mode.

Right button: SPA Mode “0%” setting.

Up/Down buttons: Set the chlorination output level for the spa water from 0 to 20%. To prevent over chlorination of the spa, the EasyTouch system will automatically drop the chlorine output levels to 1/20th of the current pool output when the spa is switched on. For example, if the pool output level is set to 60%, when the spa is switched on, the chlorination level is reduced to 3%.

Right button: Move to the next set of settings (2/2).

Up/Down buttons: Select 2/2.

Right button: Move the Super Chlorination settings.

Up/Down buttons: Set Super Chlorination **On** or **Off**. See note below about Super Chlorination.

Right button: Move to “Run Hours” setting.

Up/Down buttons: Set the number of hours to run Super Chlorination. 24 hours is the default setting. Run hours can be set from 0 to 72 hours.

Press the **Menu** button to save the settings and to return to the Settings menu options. Press the button again to return to the main menu options or press again to return to the main screen.

Note: For IntelliChlor status messages, see “Diagnostics: Chlorinator” page 51.

About Super Chlorination: The Super Chlorination feature is used to introduce large amounts of chlorine into the pool water if there has been heavy rain fall, many bathers in the pool, cloudy water conditions, etc. When Super Chlorination is enabled, the system will switch on the filter pump, set the pool/spa valves to the correct position, and set the IntelliChlor chlorine generator to maximum output. This process continues for 24 hours. At the end of the Super Chlorination process, the pool will return to normal operation. It is possible to manually stop the Super Chlorination process and switch off the filter pump using the Filter (F) button on the main control panel at the pool equipment pad. When the filter pump is switched on again using the Filter (F) button, the Super Chlorine process will resume for the duration of time left.

Settings Menu: ThermalFlo

ThermalFlo screen

From the ThermalFlo® heat pump screen you can view the current ThermalFlo operation status, and set the unit to operate with for heating only, cooling only, or both heating and cooling if the unit is reversible. Connection from ThermalFlo is via the COM PORT on the EasyTouch motherboard. See page 63 for ThermalFlo to EasyTouch COM port wiring information. The ThermalFlo must be set to default ADDRESS 1. One ThermalFlo unit can be connected to EasyTouch.

*Note: Once the ThermalFlo is enabled, use the **Left** and **Right** arrow buttons to adjust the ThermalFlo temperature and cooling, (see page 5).*

ThermalFlo

To access ThermalFlo settings menu:

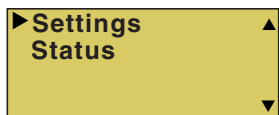

Right button: Access the “Settings” menu.

Up/Down buttons: Select **Yes** or **No** to enable or disable ThermalFlo.

Right button: Move to the “Heating” setting.

Up/Down buttons: Select **Yes** or **No** to use for heating.

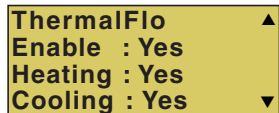

Right button: Move to the “Cooling” setting.

Up/Down buttons: Select **Yes** or **No** to use for cooling only or if the unit is reversible select both heating and cooling.

Press the **Menu** button to save the settings and to return to the ThermalFlo Settings and Status menu options.

Press the **Menu** button three times to return to the main screen.

To access ThermalFlo Status menu:

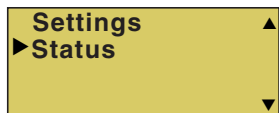

Right button: Access the “Status” menu.

Press the **Menu** button to return to the main screen.

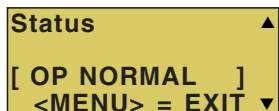

Settings Menu: Circuit Names

Labeling Circuit Buttons in the EasyTouch Load Center

EasyTouch is factory configured to display each output circuit by its generic name (e.g. AUX 1, AUX 2, etc.). These generic circuit auxiliary names can be assigned a new names which are more descriptive of the equipment being controlled. This makes it much easier to operate all of the pool, spa and lighting equipment without having to memorize what each output controls.

For circuit identification, adhesive backed circuit name labels are provided for placement next to each auxiliary control panel button. Use the written list of circuit names (buttons) that you made while setting up the EasyTouch system load center. Identify what you labeled circuit button 1, button 2 etc. The circuit names you assign should match the labels you put on the EasyTouch load center control panel buttons and/or the optional Indoor Control Panel buttons. Note that examples shown below use the factory set generic output names displayed in the EasyTouch control panel menus.

Circuit Names

To assign circuit names:

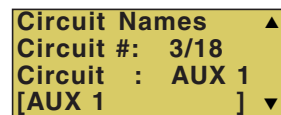

Up/Down buttons: Select the circuit number 1/18. Press the **Up button** two times to select AUX 1. The generic circuits names are: Spa (1/18), Pool (2/18), Aux 1-7 (EasyTouch 8), Aux 1-3 (EasyTouch 4), Ft 1. (10/18) - Ft. 8 (17/18), AuxX (18/18 - Aux Extra). The circuit number 1/18 corresponds to its assigned circuit name. This name can be changed to suite the function. Aux Extra is only available if the Solar output (J17) plug on the EasyTouch motherboard is not being used for solar equipment. Use the Solar button to switch the “extra” auxiliary circuit on and off (see page 4).

Right button: Move to EasyTouch preset circuit names and user defined custom circuit names.

Up/Down buttons: Scroll through the list of alphabetical programmed names. If you cannot find a name to match your circuit, you can create your own custom name. Repeat for all the circuit buttons that you wish to assign names to. For a complete list of EasyTouch circuit names, see page 36.

Press the **Menu** button to save the settings and to return to the Settings menu options. Press the button again to return to the main menu options or press again to return to the main screen.

Note: After a generic circuit name is changed and saved, the new name is displayed in the menu settings. You can view the default generic circuit names in the menu settings before they were changed by enabling “Cir Names.” Refer to “Diagnostics: Cir Names (Off),” on page 52.

Hi-Temp/Lo-Temp Controls for Single Body System

For an EasyTouch single body system, you have the option to control your pool and spa temperature settings using the Valves (V) button or the Spa (Hi-Temp) and Pool (Lo-Temp) button on the optional Indoor control Panel. Change the circuit name **SPA** to **HI-TEMP** and **POOL** to **LO-TEMP** so that the display shows the correct temperature controls for your single body system.

EasyTouch Circuit Names

AERATOR	NOT USED	Custom Circuit Names (11 characters maximum)	
AIR BLOWER	OZONATOR	USERNAME-01	_____
AUX 1	PATH LIGHTS	USERNAME-02	_____
AUX 2	PATIO LTS	USERNAME-03	_____
AUX 3	PERIMETER L	USERNAME-04	_____
AUX 4	PG2000	USERNAME-05	_____
AUX 5	POND LIGHT	USERNAME-06	_____
AUX 6	POOL PUMP	USERNAME-07	_____
AUX 7	POOL	USERNAME-08	_____
AUX 8	POOL HIGH	USERNAME-09	_____
AUX 9	POOL LIGHT	USERNAME-10	_____
AUX 10	POOL LOW		
AUX EXTRA	POOL SAM		
BACKWASH	POOL SAM 1		
BACK LIGHT	POOL SAM 2		
BBQ LIGHT	POOL SAM 3		
BEACH LIGHT	SECURITY LT		
BOOSTER PUMP	SLIDE		
BUG LIGHT	SOLAR		
CABANA LTS	SPA		
CHEM. FEEDER	SPA HIGH		
CHLORINATOR	SPA LIGHT		
CLEANER	SPA LOW		
COLORWHEEL	SPA SAL		
DECK LIGHT	SPA SAM		
DRAIN LINE	SPA WTRFLL		
DRIVE LIGHT	SPILLWAY		
EDGE PUMP	SPRINKLERS		
ENTRY LIGHT	STREAM		
FAN	STATUE LT		
FIBER OPTIC	SWIM JETS		
FIBER WORKS	WTR FEATURE		
FILL LINE	WTR FEAT LT		
FLOOR CLNR	WATERFALL		
FOGGER	WATERFALL 1		
FOUNTAIN	WATERFALL 2		
FOUNTAIN 1	WATERFALL 3		
FOUNTAIN 2	WHIRLPOOL		
FOUNTAIN 3	WTRFL LGHT		
FOUNTAINS	YARD LIGHT		
FRONT LIGHT	FEATURE 1		
GARDEN LTS	FEATURE 2		
GAZEBO LTS	FEATURE 3		
HIGH SPEED	FEATURE 4		
HI-TEMP	FEATURE 5		
HOUSE LIGHT	FEATURE 6		
JETS	FEATURE 7		
LIGHTS	FEATURE 8		
LOW SPEED			
LO-TEMP			
MALIBU LTS			
MIST			
MUSIC			

Settings Menu: Circuit Functions

Assigning Circuit Functions

From the “Circuit Functions” menu you can assign special logic to the cleaner pump, spa spillway, lights and MagicStream laminar circuits. For example, when setting up an automatic pool cleaner pump, you would assign the circuit function “MASTER CLEANER.” With this "Cleaner" logic the cleaner pump would force the filter pump on, and the cleaner pump would start after a delay of five minutes. The cleaner pump would automatically shut off whenever the spa and/or solar is switched on.

Freeze Protection

Freeze protection switches on a circuit if the outside air temperature sensor detects the temperature is getting close to freezing (below 35° F). The system will switch on all circuits that have been assigned freeze protection, and runs the circuits for 15 minutes to stop the pipes from freezing. This is especially important if there is a pool and spa combination. If freeze protection is set to both the spa and pool circuits, the filter pump switches on and the pool and spa valves alternate every 15 minutes to keep the water moving in both the pool and spa. This process continues until the freeze condition is over.

Circuit Functions

Getting There

MENU ▼ SETTINGS ▼ CIRCUIT Func. ► CIRCUIT/ Func.

To assign a circuit function and freeze protection:

Circuit/Fun.	▲
[SPA]
[Master Spa]
Freeze: Yes/No	▼

Up/Down buttons: Choose the circuit name (displayed on the second line). The generic circuit names are: Spa [Master Spa - Freeze protection on by default], Pool [Master Pool - Freeze protection on by default], Aux 1-7 (EasyTouch 8), Aux 1-3 (EasyTouch 4), Feature 1-8 and Aux Extra. Aux Extra is only available if the Solar output (J17) plug on the EasyTouch motherboard is not being used for solar equipment. Use the Solar button to switch the “extra” auxiliary circuit on and off (see page 4).

Right button: Move to the “Circuit Function” setting to select the circuit function for the select circuit name displayed on the line above.

Up/Down buttons: Select the circuit function. This is the circuit that you wish to assign the function logic to. For a complete list of preset circuit functions, see “Preset Circuit Functions,” on page 38.

Right button: Move to Freeze Protection setting.

Up/Down buttons: Select **Yes** or **No** to assign freeze protection to this circuit. If “Yes” is selected, the circuit will switch on if the air temperature drops to 35° F.

Note: for the POOL circuit the filter pump will have freeze protection. For the SPA circuit the filter pump will run and the pool/spa valves will switch between pool and spa at 15 minutes intervals throughout the freeze condition. For the MASTER CLEANER circuit freeze protection is generally not needed for pool cleaner pumps since they get water flow from the filter pump. Just make sure that POOL has freeze protection.

Press the **Menu** button to save the settings and to return to the Settings menu options. Press the button again to return to the main menu options or press again to return to the main screen.

Preset Circuit Functions

Generic	No special Logic. Simple On/Off control of a circuit with all the programmable capabilities.
Master Spa	Works with automatic pool cleaner pumps or cleaner valve actuator. It does the following: <ul style="list-style-type: none"> - Forces the filter pump on 5 minutes before the cleaner pump switches on. - Switch the cleaner off when the spa is on. - Switch the cleaner off for 5 minutes when the solar heating begins.
Master Pool	Works with automatic pool cleaner pumps or cleaner valve actuator. It does the following: <ul style="list-style-type: none"> - Forces the filter pump on 5 minutes before the cleaner pump switches on. - Switch the cleaner off when the spa is on. - Switch the cleaner off for 5 minutes when the solar heating begins.
Master Cleaner	Works with automatic pool cleaner pumps or cleaner valve actuator. It does the following: <ul style="list-style-type: none"> - Forces the filter pump on 5 minutes before the cleaner pump switches on. - Switch the cleaner off when the spa is on. - Switch the cleaner off for 5 minutes when the solar heating begins.
Light	Allows special lighting features to work, such as ALL lights on or ALL lights off.
SAM Light	Activates special color lighting programs on other screens on the Indoor Control Panel when used with SAM pool lights. For example, you can have ALL lights on or ALL lights off.
SAL Light	Activates special color lighting programs on other screens on the Indoor Control Panel when used with SAL spa lights. For example, you can have ALL lights on or ALL lights off.
Photon Generator	Photon Generator® light source allows Pentair Fiberworks fiber optic bulb be operated by the Lights menu features Sync, Rotate, ALL ON and ALL OFF when used with SAM and SAL lighting.
Color Wheel	Activates special color lighting programs on other screens on the Indoor Control Panel when used with Pentair Fiberworks. For example, you can have ALL lights on or ALL lights off.
Spillway	For pool/spa combinations where the spa is raised above the pool. This setting moves the return valve so that the filter pump pulls the water from the pool and returns it to the spa, creating a water fall effect. Automatic pool cleaners are turned off when this feature is turned on.
Floor Cleaner	This setting moves a 3-way valve every 20 minutes alternating flow between 2 cleaner system valves that feed the pop-up heads.
IntelliBrite	Activate an Intellibrite LED light.
MagicStream	Activate a MagicStream laminar.

Settings Menu: Custom Names

There are nearly 100 circuit names available to choose from. If you cannot find one to fit your application you can create up to 10 custom names. Each name can be up to 11 alphanumeric characters. After a custom name is saved, it is then available for selection (see page 36).

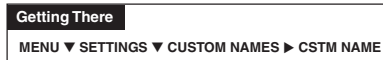

Custom Name

To assign a custom circuit name:

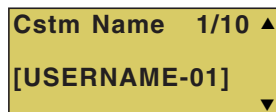

Up/Down buttons: Select a custom circuit name number (1-10). You can create up to 10 custom circuit names.

Right button: Move to custom circuit name setting.

Up/Down/Right buttons: Enter the custom circuit name (11 characters maximum).

Press the **Menu** button to save the settings and to return to the Settings menu options. Press the button again to return to the main menu options or press again to return to the main screen.

Settings Menu: Valves

This feature lets you assign a circuit to Valve A or B. The EasyTouch system can drive two auxiliary valve actuators (A and B) for applications such as solar heating and water features. By assigning AUX circuits to control valve actuators, you can conserve auxiliary circuits for high voltage relays for controlling pumps and lights.

Valve A: Resides on the EasyTouch motherboard. If solar heating is setup and is not configured as a heat pump, then Valve A is dedicated for controlling the solar heating valve actuator. Solar is enabled in the “Solar” menu. The Valve A selection will display “USED SOLAR.”

Valve B: Resides on the EasyTouch motherboard. Can be configured to be controlled by any circuit.



Valves

To assign a circuit to Valve A and Valve B:

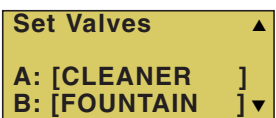

Up/Down buttons: Select a circuit to assign to Valve A. The generic circuit selections are: The generic circuits names are: None, Spa, Pool, Aux 1-7 (EasyTouch 8), Aux 1-3 (EasyTouch 4), Feature 1-8, Solar and Heater. “Aux Extra” is displayed only available if the Solar output (J17) plug on the EasyTouch motherboard is not being used for solar equipment. Use the Solar button to switch the extra circuit on and off (see page 4). Selecting “None” does not assign a circuit.

Right button: Move to Valve B setting.

Up/Down buttons: Select a circuit to assign to Valve B. See above for the generic circuits names.

Press the **Menu** button to save the settings and to return to the Settings menu options. Press the button again to return to the main menu options or press again to return to the main screen.

Settings Menu: 2-Speed Pump

Equipment circuits selected in this menu will automatically switch a two-speed filter pump to high speed when these circuits are on. If a two-speed pump is assigned to solar, a cleaner or a pump, when activated the pump will automatically run for five minutes in high speed then switch to low speed. For example, when on, the filter pump will switch to high speed whenever the JETS or CLEANER is on. There must be a two-speed relay installed in the EasyTouch Load Center in order for the “2-Speed Pump” menu settings to function.

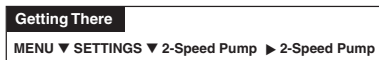

2-Speed Pump

To configure a two-speed pump to a circuit:

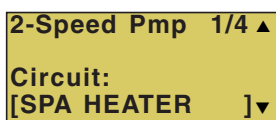

Up/Down buttons: Select a circuit that will switch the filter pump to high speed. You can set up to four circuits to use a two-speed pump (1/4, 2/4, 3/4, 4/4).

Right button: Move to assign a circuit setting.

Up/Down buttons: Select the circuit to assign to a two-speed pump. The generic circuits names are: None, Spa, Pool, Aux 1-7 (EasyTouch 8), Aux 1-3 (EasyTouch 4), Feature 1-8, Solar, Heater, Pool Heater, Spa Heater and Freeze. “Aux Extra” is displayed only available if the Solar output (J17) plug on the EasyTouch motherboard is not being used for solar equipment. Use the Solar button to switch the extra circuit on and off (see page 4). Selecting “None” does not assign a circuit. *Note: You can use a Feature circuit to change a 2-Speed pump to high speed.*

Right button: Assign the next circuit (2/4).

Up/Down buttons: Select the first digit for the circuit number (1/4, 2/4, 3/4, 4/4).

Right button: Move to circuit setting.

Up/Down buttons: Select the next circuit. When finished press the **Menu** button. Press the **Menu** button to save the settings and to return to the Settings menu options. Press the button again to return to the main menu options or press again to return to the main screen.

Settings Menu: Solar

Use the solar settings to setup solar or configure solar as a heat pump:

Setting Up Solar Control: Ensure that the solar temperature sensor is installed.

About Installing Solar Heating: First, install the solar sensor at the collectors and connect to the EasyTouch load center. If “HEAT PUMP” is selected and is being used in place of a solar heating system, install Solar sensor near the EasyTouch Load Center. Connect the wires to the SOLAR screw terminals according to the wiring diagram on page 58. Plug the solar valve actuator cable into three-pin socket marked VLV A on the EasyTouch motherboard. If a solar booster pump is being installed, connect the pump to a power relay and plug a low voltage cable from relay into the two-pin socket marked SOLAR on the EasyTouch motherboard.

Note: If Solar is not selected (No), the EasyTouch menu selections display “AUX EXTRA” instead of “SOLAR.” This allows the solar plug (J17) on the EasyTouch motherboard to be used as an “extra” auxiliary output circuit. The Solar button is used to switch on and off the extra auxiliary circuit.

To access the Solar menu:



Solar

To enable a solar heater and set the temperature start and run time settings:

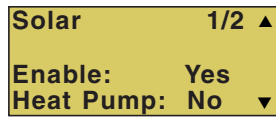

Up/Down buttons: Select **Yes** or **No** to enable solar (1/2). In order to display the solar selection as a heat source in the main screen, select **Yes**.

Right button: Move to the Heat Pump setting.

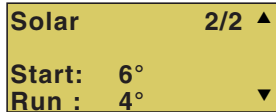

Up/Down buttons: Select **Yes** or **No** to enable solar as a heat pump. **Heat Pump Control instead of Solar:** Select **Yes** if a heat pump is being used in place of a solar heating system. If Solar is set to heat pump, Valve A is free for other circuits.

Right button: Select 2 of 4 (2/4) to access the solar temperature differential start up and run settings.

Up/Down buttons:

Start: Set the temperature differential to start heating from 3° to 9°. For example, if “Start” is set to 3°, this ensures that the temperature has to deviate by 3° at least to the specified set point temperature (in the Heat menu, on page 23) before it switches on. Once the solar comes on it will start converging as it is heating. This ensures that it will not continually be switching on and off.

Run: Set the temperature differential to stop heating from 2° to 5°. This setting sets how close to the target set point temperature to switch off solar heat.

Press the **Menu** button to save the settings and to return to the Settings menu options. Press the button again to return to the main menu options or press again to return to the main screen.

Settings Menu: Delays

Setup which functions (pool/spa, and valves) to assign the delay feature. Delays can be assigned to the following equipment.

- **Heater Cool-Down Delay Cancel:** Shuts Filter Pump off immediately.
- **2-Speed Filter Pump five-minute START on HIGH SPEED Delay Cancel:** Shifts pump to low speed.
- **Automatic Pool Cleaner START Delay:** Starts Cleaner Pump immediately, without normal delay in which the filter pump first runs for 5 minutes.
- **Automatic Pool Cleaner SOLAR Delay:** Allows Cleaner Pump to run even though solar delay has shut it off for 5 minutes.

Some heaters require a cooldown cycle before being switched off. This can be setup to run the filter pump an additional ten minutes to dissipate residual heat built up inside the heater combustion chamber. You can also cancel the delay feature. For information about using the cancel delay feature, refer to “Delay Cancel” on page 24.



Delays

To assign the delay feature:

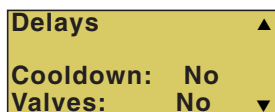

Press the **Up/Down buttons** to select **Yes** or **No** to enable or disable delays for the pool and spa circuits (“Cooldown”). Press the **Right button** to move to the valves setting. Press the **Down buttons** to select **Yes** or **No** to enable or disable delays for valves. Press the **Menu** button to save and to return to the Settings menu options. Press the **Menu** button again to return to the main menu or press again to go to the main screen.

Settings Menu: F° / C° (Fahrenheit/Celsius)

The temperature settings for the water, solar and air can be displayed in either Fahrenheit or Celsius.



F° / C°

To change the temperature units:



Up/Down buttons: Select either Fahrenheit or Celsius. Press the Menu button to save the settings and to return to the Settings menu options. Press the **Menu** button again to return to the main menu options or press again to return to the main screen.

Settings Menu: iS4 Spa-Side Remote Controller

You can specify any iS4 Spa-Side remote button to control different functions by assigning each button to a specific circuit. For example, you can use the iS4 Spa-Side remote to activate the spa circulation and for operating auxiliary equipment such as heater, lights, jet pump, heat boost, air blower, waterfall, etc.). You can also use the “Pump Incrs” and “Pump Decrs” circuit to increase or decrease the pump speed for an IntelliFlo VF (GPM) or VS (RPM) pump. For example, if the “Pump Incrs” circuit is assigned to an iS4 button, each press of the button will increase the pump speed in specific speed increments as specified in the “iSx Pump Cntrl” menu setting (see page 44). Speed increments are set from 10 to 250 RPM (or 1 to 10 GPM, for the IntelliFlo VF).



Assign iS4

Before configuring the iS4 Spa-Side remote controller assign names to the circuits (see page 42).

To assign iS4 Spa-Side buttons:

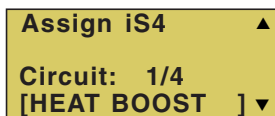

Up/Down buttons: Select a circuit to one of the iS4 buttons. You can set up to four circuits (1/4, 2/4, 3/4, 4/4).

Right button: Move to the circuit setting.

Up/Down buttons: To configure the first button on the iS4 Spa-Side Remote, scroll through the circuit names and find the circuit that you would like to assign to the first button on the iS4. The generic circuits selections are: None, Spa, Pool, Aux 1-7 (EasyTouch 8), Aux 1-3 (EasyTouch 4), Feature 1-8, Solar (if selected in “Heat” menu), Heat Boost, Heat Enable, Pump Incrs, Pump Decrs. “Aux Extra” is displayed only available if the Solar output (J17) plug on the EasyTouch motherboard is not being used for solar equipment. Use the Solar button to switch the extra circuit on and off (see page 4). Selecting “None” does not assign a circuit.

Note: The “Heat Boost” feature will switch on the heater for seven minutes to increase the spa water temperature. Each time the spa Heat Boost button is pressed, the temperature will increase about 1° F. The temperature will not go beyond the 104° F limit.

Right button: Assign the next circuit (2/4).

Up/Down buttons: Select the first digit for the circuit number (1/4, 2/4, 3/4, 4/4) and repeat the procedure for the other three buttons.

Press the **Menu** button to save the settings and to return to the Settings menu options. Press the button again to return to the main menu options or press again to return to the main screen.

Note: To disable or enable the iS4 Spa-Side remote, see *Settings Menu: Spa Side,* on page 49.

Settings Menu: iS10 Spa-Side Remote Controller

You can specify any iS10 Spa-Side remote button to control different functions by assigning each button to a specific circuit. The iS10 has ten assignable circuit buttons; five buttons on the top row and five buttons on the bottom row. You can also use the “Pump Incrs” and “Pump Decrs” circuit to increase or decrease the pump speed for an IntelliFlo VF (GPM) or VS (RPM) pump. For example, if the “Pump Incrs” circuit is assigned to an iS10 button, each press of the button will increase the pump speed in specific speed increments as specified in the “iSx Pump Cntrl” menu setting (see page 44). Speed increments are set from 10 to 250 RPM (or 1 to 10 GPM, for the IntelliFlo VF).

Assign iS10



Before configuring the iS10 Spa-Side remote controller assign names to the circuits (see page 35).

To assign iS10 Spa-Side buttons:



Up/Down buttons: Select the “Top” or Bottom” row to assign circuits to.

Right buttons: Select a circuit to one of the iS10 buttons. Five top row buttons can be assigned circuits (1/5, 2/5, 3/5, 4/5 and 5/5). See “iS10 button assignments” below for details.

Right button: Move to the circuit setting.

Up/Down buttons: To configure the first button on the iS10 Spa-Side Remote, scroll through the circuit names and find the circuit that you would like to assign to the first button on the iS4. The generic circuits selections are: None, Spa, Pool, Aux 1-7 (EasyTouch 8), Aux 1-3 (EasyTouch 4), Feature 1-8, Solar (if selected in “Heat” menu), Heat Boost, Heat Enable, Pump Incrs, Pump Decrs. “Aux Extra” is displayed only available if the Solar output (J17) plug on the EasyTouch motherboard is not being used for solar equipment. Use the Solar button to switch the extra circuit on and off (see page 4). Selecting “None” does not assign a circuit.

Note: The “Heat Boost” feature will switch on the heater for seven minutes to increase the spa water temperature. Each time the spa Heat Boost button is pressed, the temperature will increase about 1° F. The temperature will not go beyond the 104° F limit.

Right button: Assign the next circuit (2/5).

Up/Down buttons: Select the first digit for the circuit number (1/5, 2/5, 3/5, 4/5) and repeat the procedure for the other three buttons.

Press the **Menu** button to save the settings and to return to the Settings menu options. Press the button twice to return to the main screen.

iS10 button assignments

Button 1	SPA	POOL
	HI-TEMP	LO-TEMP
Button 2	AUX 1	AUX 5
Button 3	AUX 2	AUX 6
Button 4	AUX 3	AUX 7
Button 5	AUX 4	AUX 8

Settings Menu: iSx Pump Cntrl

From this menu setting you can specify the IntelliFlo VS or VF pump speed (RPM, GPM) in step increments, for the assigned iS4 or iS10 button using the “Pump Incrs” or “Pump Decrs” circuit (see page 44 and 45). For example, the “Pump Incrs” and “Pump Decrs” circuit can be assigned to any two iS10 buttons. Each press of the assigned “increase” button will increase the pump speed in specific speed increments, as specified in the “iSx Pump Cntrl” menu setting. Speed increments are set from 10 to 250 RPM or 1 to 10 GPM.

Assign iSx Pump Cntrl

Before configuring the pump step speed, be sure to specify the IntelliFlo pump number and type in the IntelliFlo menu (“Pump #1, Pump #2,” Pump Type), see page 30.

Getting There

MENU ▼ SETTINGS ▼ iSx PUMP CNTRL ► ASSIGN IS10 & 4QT4

To assign a pump step speed:

**Assign iS10 & 4
Pump Controls
Pump Number: 1
Step RPM: 010**

Up/Down buttons: Select the “Pump Number” as specified in the IntelliFlo menu (see page 30).

Right buttons: Select the pump “Step” speed.

Up/Down buttons: Adjust the “Step” pump speed. Settings are:

- IntelliFlo VS, 10 to 250 RPM
- IntelliFlo VF 1 to 10 GPM.

**Assign iS10 & 4
Pump Controls
Pump Number: 1
Step GPM: 001**

Press the **Menu** button to save the settings and to return to the Settings menu options. Press the button twice to return to the main screen.

Settings Menu: QuickTouch (QT4) Wireless Remote

The QuickTouch QT4 wireless remote controller provides switching of up to four circuits. For example, you can use the QT4 wireless remote to activate the spa circulation, and for operating three auxiliary pieces of equipment (such as heat enabled, lights, jet pump, heat boost, air blower, waterfall, etc.).

Each of the four functions on the QT4 wireless controller has an on and an off button. To switch a circuit on or off, press and hold the appropriate button for at least a full second.

The QT4 buttons can be assigned to any available circuit. However, the QT4 has the following preset circuits assigned to the four buttons:

- Spa button activates the spa circuit.
- A button activates **Auxiliary 1** circuit.
- B button activates **Auxiliary 2** circuit.
- C button activates **Auxiliary 3** circuit.

Assign QT4



To assign circuits to the QuickTouch wireless controller buttons:

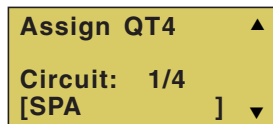

Up/Down buttons: Select a circuit to assign to one of the QuickTouch wireless remote buttons. You can set up to four circuits (1/4, 2/4, 3/4, 4/4).

Right button: Move to the circuit setting.

Up/Down buttons: To configure the first button (1/4) on the QuickTouch wireless remote. Use these buttons to scroll through the circuit names and find the circuit that you would like to assign to the first button. The generic circuits selections are: None, Spa, Pool, Aux 1-7, Feature 1-8 (EasyTouch 8), Aux 1-3, Feature 1-4 (EasyTouch 4), Aux Extra, Heat Boost and Heat Enable. Selecting “None” does not assign a circuit. “Aux Extra” is only available if the Solar output (J17) plug on the EasyTouch motherboard is not being used for solar equipment. Use the Solar button to switch the “extra” auxiliary circuit on and off (see page 4).

***Note:** The “Heat Boost” feature will switch on the heater for seven minutes to increase the spa water temperature. Each time the spa Heat Boost button is pressed, the temperature will increase about 1° F. The temperature will not go beyond the 104° F limit.*

Right button: Assign the next circuit (2/4).

Up/Down buttons: Select the first digit for the circuit number (1/4, 2/4, 3/4, 4/4), then repeat the procedure for the other three buttons.

Press the **Menu** button to save the settings and to return to the Settings menu options. Press the button again to return to the main menu options or press again to return to the main screen.

Settings Menu: Man Heat (Off/On)

By default manual heat (Man Heat) is set to “On,” which allows your spa to begin to heat whenever it is manually switched on, (by pressing the **Valves (V)** button and **Filter Pump (F)** button on the outdoor control panel or the **Spa** button on the Indoor Control Panel), even if the Heat menu setting is set to “OFF” (see page 23). Your spa will also begin to heat when switched on by the iS4 Spa-Side remote. This feature allows you to program your spa to filter daily with the heater set to off, and then be ready to heat whenever the Spa button is pressed manually.



Man Heat

To enable or disable spa manual heat when switched on manually:

iSx Pump Cntrl	▲	<p>Right button:: Select Off to disable or On to automatically begin spa heating whenever the spa is switched on manually.</p> <p>Press the Menu button to save the settings and to return to the main screen.</p>
QuickTouch		
Man Heat [On]		
Calibration	▼	

Settings Menu: Calibration

The EasyTouch system includes two temperature sensors (10 kΩ) for water and ambient air temperature. You can also add an additional sensor for controlling solar heating systems. Generally, these sensors are accurate and you do not have to calibrate them. However, long plumbing runs and water features can cause temperatures at a body of water to be different from the temperature sensor reading. You can manually recalibrate the sensors to adjust for this. You only need to calibrate one body of water, since the temperature sensor is common to both the pool and spa. The system must be in “Service” mode to calibrate sensors (see “Mode” button on the EasyTouch outdoor control panel).



Calibration

Before you start, you need an accurate all weather thermometer. If you are calibrating the air sensor, wait until the sensor is not in direct sunlight. For the air temperature sensor, make sure that the sensor is located in the shade for accurate readings.

To calibrate the water, air and solar temperature sensors:

1. Press the **Mode** button on the control panel to place the system in “Service” manual mode.
2. Press the **Filter Pump (F)** button to switch on the pool/spa filter pump.
3. Place the thermometer in the spa or pool water. Take an accurate temperature reading. When calibrating the air sensor, place the thermometer next to the air sensor. The air sensor is normally located near or under the EasyTouch load center enclosure, not inside the enclosure. Take an accurate temperature reading in the shade.
4. Use the **Up** or **Down** buttons to raise or lower the water temperature to match the corresponding thermometer temperature reading.
5. After calibrating the water sensor, use the **Right** button to move to the “AIR” setting and repeat step 4 and repeat the procedure for the solar sensor. Ensure that the solar sensor is in the sun for accurate readings.
6. After calibrating all the sensors, press the **Menu** button to save the settings and to return to the Settings menu options. Press the button again to return to the main menu options or press again to return to the main screen.

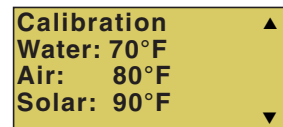

Settings Menu: Erase EEPROM (Erase System Memory)

EasyTouch system configuration data is stored and retained in “Flash” memory in an EEPROM located on the control panel motherboard and optional Indoor Control Panel. The EasyTouch user system configuration data can be erased to restore the factory defaults settings. System information automatically downloads from programmed components to non-programmed components in case of accidental memory loss and to ease board replacement. Any optional controllers (iS4, iS10 or QuickTouch QT4 controller) that were configured need to be reconfigured.

Erase EEPROM

The following procedure describes how to erase the system memory from either the main EasyTouch control panel or the EasyTouch Indoor Control Panel.

CAUTION: This procedure will erase all system settings. Any optional controllers will need to be reconfigured.

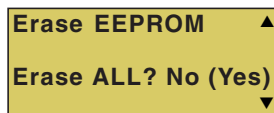

Up/Down button: Select **Yes**.

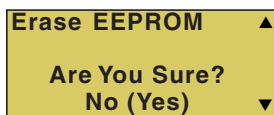

Right button: The message “Erase EEPROM Are You Sure? No” is displayed.
Up/Down button: Select **Yes**.

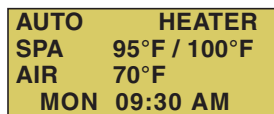

Right button: Press this button to erase system data and restore the factory defaults. The display will go blank, then the main screen will be displayed.

Settings Menu: Set Password

If required, the password feature allows you to password protect the EasyTouch control panel. To access a password protected control panel, you must enter the correct four digit password before access is granted.

Password

To enable the password protect feature:

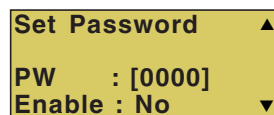

Up/Down button: Select the password **first** digit (0-7) of the four digit password.

Right button: Select the next password digit. Repeat the previous step to enter each of the password digits.

Right button: After you are finished entering the four password digits, press the Right button to enable the password feature.

Up/Down button: Select **Yes** enable the password feature.

Press the **Menu** button three times to save the settings and to return to the main screen.

Note: If the password feature is enabled, the current four digit password can be viewed from the EasyTouch outdoor control panel in the “Set Password” setting.

Settings Menu: Backlight

Use the backlight “On Time” option to set the duration that the backlight will stay on. The “Brightness” setting allows you to set the backlight brightness. These options can help to reduce power consumption and extend battery life. The Backlight options are:

- **On Time:** Backlight will stay on for 60 seconds, 30 seconds, five minutes, or “Backlight” feature is off . The default setting is 30 seconds.
- **Brightness:** Backlight brightness can be set to low, medium or high. The default setting is medium.

Backlight

To set the backlight duration and brightness:



Up/Down buttons: Select **5 S**, **15 S**, **30 S**, **60 S**, **5 M** or **OFF** for the backlight to stay on.

Right button: Select **LOW**, **MED** or **HI** for the backlight brightness setting.

Press the Back button to save the settings and to return to the previous screen.

Settings Menu: Power Save

This option sets the time that the EasyTouch wireless control panel will shut down if there is no control panel activity. Use the power save options to reduce power consumption and extend battery life. The options are:

- **Power save:** Set the power save time to 15, 30, or 60 seconds, or five minutes before the unit shuts down. The default time is 60 seconds.

Note: If the unit is not used for 60 (default) seconds the power save function switches off the unit. To switch the unit on, press the “POWER ON” button (see page 4).

Idle Time

To set the idle time for the EasyTouch wireless control panel:

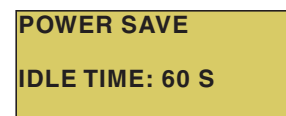

Right or Up/Down buttons: Select **30 S**, **60 S** or **5 M**.

Press the Back button to save the settings and to return to the previous screen.

Settings Menu: Wireless Addr

Use this feature to configure the EasyTouch wireless control panel with a unique communication address to allow the wireless device to operate with the EasyTouch outdoor control panel (see page 11).

Wireless Addr

Getting There
MENU ▼ SETTINGS ▼ WIRELESS ADDR ► Press Right arrow button

To search and lock on to the EasyTouch wireless control panel:

Address Wireless Scanning ...

Right button: Press this button to automatically search and lock on to the EasyTouch Wireless Control Panel within range of the EasyTouch transceiver antenna. For more information about the EasyTouch wireless control panel, refer to the EasyTouch Wireless Control Panel User's Guide (P/N 520688).

Address Wireless Sending Address..
<MENU>

Press the **Menu** button to save the settings and to return to the Settings menu selections.

Spa Side [Off/On]

Enable or disable the iS4 Spa Side remote. This feature is useful for families with young children or when you go on vacation. It allows you to switch off the iS4 Spa Side remote at the control panel so that the remote cannot be used.

Spa Side

To enable or disable the iS4 Spa Side remote:

Getting There
MENU ▼ SPA SIDE [On/Off]

Delay Cancel Schedules Settings Spa Side [On]

Right button: Select **On** or **Off** to enable or disable the spa side remote. Press the **Menu** button to save the settings and to return to the main screen.

Diagnostics Menu: Software Rev

Displays the current software revision for the EasyTouch main control panel and the optional indoor control panel.

Getting There
MENU ▼ DIAGNOSTICS ▼ SOFTWARE REV

Software Rev
UIC: 1.02
UOC: 1.02

UIC: Displays the current software revision level for the indoor control panel.
UOC: Displays the current software revision level for the outdoor control panel.
Press the **Menu** button to return to the Settings menu options. Press the button again to return to the main menu options or press again to return to the main screen.

Diagnostics Menu: Bootloader Rev

Displays the current bootloader revision for the indoor control panel and the main EasyTouch control panel.

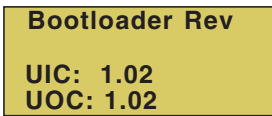

UIC: Displays the current bootloader revision level for the indoor control panel.

UOC: Displays the current bootloader revision level for the outdoor control panel.

Press the **Menu** button to return to the Settings menu options. Press the button again to return to the main menu options or press again to return to the main screen.

Diagnostics Menu: Self Test

Tests the control panel LCD and buttons. Follow the on-screen prompts to perform the tests.



Note: If the Indoor Control Panel is connected to the EasyTouch outdoor control panel, select “LINK CLOSED” in the UART test to abort the UART test. This allows the test to complete with and display PASSED.

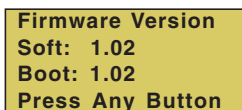

Press the **Right** button to display the current software and boot loader revision levels for the EasyTouch outdoor control panel.

Press the **Right** button to start the test:

Press the **Right** button to start the test:



Display Test: Press any button to start the LCD test.

Backlight Test: Press the **Left** then **Right** button.

Contrast Test: Press any button to continue.



LED Test: Press any button to continue. All of the button LEDs will be tested.

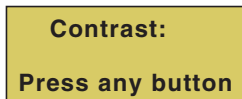

Switch Test: Press any button to continue. As prompted, press the appropriate buttons.

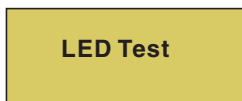

UART Test: Select “LINK CLOSED” to abort this test if the optional Indoor Control Panel is connected to the EasyTouch load center.

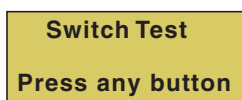

Status: Passed - Code 0: After you have completed the test an error code is displayed. “Passed” is displayed if the test was successful. For error code descriptions, see “Self Test Error Codes,” on page 54.

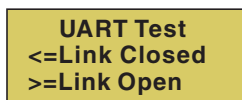

Press the **Menu** button to return to the Settings menu options. Press the button again to return to the main menu options or press again to return to the main screen.

Diagnostics Menu: Chlorinator

Displays the current IntelliChlor chlorination system status. For more information, refer to the IntelliChlor Electronic Chlorine Generator User's Guide (P/N 520589).

Getting There
MENU ▼ DIAGNOSTICS ▼ CHLORINATOR

Chlorinator ▲
Salt Level:3200ppm
Status:
[OK-NO ERRORS] ▼

Menu: Press this button to return to the Settings menu options. Press the button again to return to the main menu options or press again to return to the main screen.

SALT LEVEL: Displays the current salt level. Values from 0 to 12750 ppm in 50 ppm increments.

IntelliChlor Status messages:

SUPER CHLORINATE: IntelliChlor is in "Super Chlorination mode (see page 33 for details)

COM LINK ERROR: Check cable from IntelliChlor to EasyTouch motherboard.

Check FLOW/PCB: Check IntelliChlor electrolytic cell controller. Refer to IntelliChlor User's Guide troubleshooting information.

LOW SALT: Add salt to pool water. The water salt level is between 2500 ppm and 2900 ppm. The IntelliChlor will continue to produce chlorine at a reduced level.

VERY LOW SALT: Not enough salt in pool. The water salt level has fallen below 2500 parts per million (ppm). IntelliChlor will not produce chlorine until additional salt is added manually.

HIGH CURRENT: Check IntelliChlor electrolytic cell controller. Refer to IntelliChlor User's Guide troubleshooting information..

CLEAN CELL!: Cell has calcium build up and requires cleaning. Refer to IntelliChlor User's Guide for cleaning instructions.

LOW VOLTAGE: Check IntelliChlor electrolytic cell controller. Refer to IntelliChlor User's Guide troubleshooting information.

OK - NO ERRORS: IntelliChlor is in normal operating mode.

Diagnostics Menu: Water Temp

Displays the current water temperature for the pool and spa.

Getting There
MENU ▼ DIAGNOSTICS ▼ WATER TEMP

Water Temperature ▲
75° F ▼

Press the **Menu** button to return to the Settings menu options. Press the button again to return to the main menu options or press again to return to the main screen.

Diagnostics Menu: Solar Temp

Displays the current solar temperature.

Getting There
SPA ▼ DAGNOSTICS ▼ SOLAR TEMP

Solar Temperature ▲
85° F ▼

Press the **Menu** button to return to the Settings menu options. Press the button again to return to the main menu options or press again to return to the main screen.

Diagnostics Menu: Air Temp

Displays the current outside air temperature.

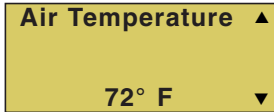

Press the **Menu** button to return to the Settings menu options. Press the button again to return to the main menu options or press again to return to the main screen.

Diagnostics Menu: Cir Name: [Off/On]

This feature is useful if you have renamed many circuits and want to view the original factory default circuit names.

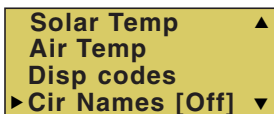

To enable:

Right button: Select **On** to view the factory default circuit names.

Press the **Menu** button to exit.

To disable:

Right button: Select **Off** to disable the feature.

Press the **Menu** button to exit.

Diagnostics Menu: Reset System

Reinitialize the Outdoor Control Panel. Resetting the Outdoor Control Panel will not effect the system configuration settings.

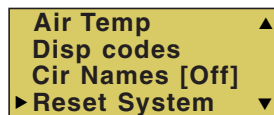

Right button: Press the Right button to reset system. The main screen will be displayed and communication will be established with the optional EasyTouch Indoor Control Panel if installed.

Diagnostics Menu: Flash Update

Use this feature to update the EasyTouch Outdoor Control Panel firmware. The EasyTouch motherboard must be connected to a personal computer (PC) in order to update the firmware.



Press the **Menu** button to exit the flash mode.

Section 3

Troubleshooting

Troubleshooting

Use the following troubleshooting information to help resolve problems that may occur when using the EasyTouch system. If by following the recommended actions you are still unable to resolve the problems, please contact Technical Support (see page vi).

Frequently Asked Questions (FAQ)

How do I setup a two-speed pump?

A two-speed pump operates using two relays and one or more circuits. The first relay turns the pump on or off. Assuming this is a filter pump, this circuit is controlled by the pool and spa circuits or any other circuit that may be tied to the filter pump (such as circuits with freeze protection, etc.). The second relay switches the pump from low speed to high speed. The default condition is low speed. Up to seven circuits (EasyTouch 8), three circuits (EasyTouch 4) may be assigned to trigger the pump to high speed. Note: These circuits do not switch the pump on.

To configure a two-speed pump relay, refer to “Settings Menu: 2-Speed Pump,” on page 40. For relay location and wiring (see page 58). The 2-Speed pump relay connector is plugged into the 2-SPD output on the EasyTouch motherboard.

Can I switch the heater on and change the temperature from the spa?

The heater may be switched on from the spa location using the iS4 Spa-Side remote or by the QuickTouch wireless remote controller. To learn more about these remotes and controllers, see page v. However, the iS4 and QuickTouch wireless remote controller cannot adjust the water temperature.

How do I switch on solar heating?

The system must first be configured for solar heating. Go to the “Heat” menu (see page 23) and enable “Solar” as the heat source (**Settings Menu: Heat > Solar**). Note: Do not set solar as a heat pump. Then the heating method must be selected for each body of water.

EasyTouch Error Messages

Error Messages

If the system detects that a sensor is not connected to the EasyTouch load center or it is defective, an error message is displayed in the “Diagnostics” menu. The following lists the sensor errors.

Error Message	Possible Cause	Solution
Air Err (Displays on the Main Screen)	Air sensor not connected to the EasyTouch motherboard.	Check that the air sensor plug is connected to J21 connector on the motherboard. Check that the sensor wire is connected properly.
Air Temperature Err (Displays in the "Diagnostics" menu)	Air sensor not connected to the EasyTouch motherboard.	Check that the air sensor plug is connected to J21 connector on the motherboard.
Water Temperature Err (Displays in the "Diagnostics" menu)	Water sensor not connected to the EasyTouch motherboard.	Check that the water sensor plug is connected to J21 connector on the motherboard.
Solar Temperature Err (Displays in the "Diagnostics" menu)	Solar sensor not connected to the EasyTouch motherboard.	Check that the solar sensor plug is connected to J21 connector on the motherboard.

Self Test Error Codes

The “Self Test” feature is intended for use by service personnel. If after performing a control panel self test (see page 50) there were no errors detected, Code 0 is displayed, indicating that there were no problems and the test was successful. If a problem is detected during the test, an error code is displayed upon completion of the test. For example Code 3 would indicate a problem with the LEDs on the control panel. If multiple errors are detected, multiple code numbers are displayed. For example, Codes 4, 2, 1, would indicate problems detected with the buttons, LEDs, and the LCD backlight on the control panel.

The following lists the control panel self test error codes.

Error Code Table

Error Code	Description
Code 0	PASS - The control panel has no problems
Code 1	LCD backlight
Code 2	LCD contrast
Code 3	LEDs
Code 4	Switch (buttons)

Maximum Programs Exceeded

The “Maximum Programs Exceeded” message displays in the “Schedules” menu if you try to create a new program after exceeding the 12 program limit. To create a new program you must first delete an existing program. For information about deleting a program, refer to “Schedule Menu” on page 25.

IntelliChlor Error Messages

IntelliChlor status and error messages are displayed in the “Chlorinator” menu (see page 51). Use the following information to resolve IntelliChlor system problems. To access the IntelliChlor menu, press **Menu > Diagnostics > Chlorinator**.

Status Message	Possible Cause	Solution
OK-NO ERRORS	IntelliChlor normal operating mode.	N/A
SUPER CHLORINATE	IntelliChlor is in "Super Chlorination" mode for 24 hours.	IntelliChlor is in "Super Chlorination mode (see page 33 or details)
COM LINK ERROR	IntelliChlor communication error with EasyTouch motherboard.	Check cable from IntelliChlor to EasyTouch motherboard.
CHECK FLOW/PCB	Check IntelliChlor electrolytic cell.	Refer to IntelliChlor User's Guide troubleshooting information.
LOW SALT	Add salt to pool water.	The water salt level is between 2500 ppm and 2900 ppm. The IntelliChlor will continue to produce chlorine at a reduced level. See IntelliChlor User's Guide for details.
VERY LOW SALT	Not enough salt in pool.	The water salt level has fallen below 2500 parts per million (ppm). IntelliChlor will not produce chlorine until additional salt is added manually. See IntelliChlor User's Guide for details.
HIGH CURRENT	Check IntelliChlor electrolytic cell.	Check IntelliChlor electrolytic cell controller. Refer to IntelliChlor User's Guide troubleshooting information.
CLEAN CELL!!	Cell has calcium build up and requires cleaning.	Cell has calcium build up and requires cleaning. Refer to IntelliChlor User's Guide for cleaning instructions.
LOW VOLTAGE	Check IntelliChlor electrolytic cell.	Refer to IntelliChlor User's Guide troubleshooting information.

System Problem Diagnosis

Use the following information to resolve system problems.

Problem: The system works in Service Mode, but Indoor Control Panel fails to operate.

Symptom	Possible Cause	Solution
Indoor Control Panel has no power - (screen, blank, no LEDs, buttons not working).	Bad wiring run from Outdoor Control Panel/motherboard in the Load Center.	Verify cable and ensure no connections are broken. In some cases a wire is broken under the insulation. The two center wires of the four conductor cable are suspect (Green and Yellow)
Indoor Control Panel lights up, but fails to operate correctly. The unit will not turn equipment on/off, or may turn some items on, but not off and may not LEDs near buttons on control panel.	Defective Cable/wiring	Verify cable and ensure no connections are broken. In some cases a wire is broken under the insulation. The two center wires of the four conductor cable are suspect (Green and Yellow)

Problem: iS4 fails to operate.

Symptom	Possible Cause	Solution
iS4 fails to operate equipment.	iS4 is disabled.	See page 49 to enable the iS4.
	Defective Wiring	Verify iS4 setup. Ensure the iS4 in question has the expected circuit assignments, and is not assigned to unused circuits.
	Incorrect configuration or button setup.	See page 42 to setup the iS4 buttons.
	Defective iS4	Replace defective iS4
iS4 fails to operate only some of the switches, but others work fine.	Defective wiring on one or more iS4 leads	Verify wiring on motherboard and iS4.
	Incorrect configuration or circuit to switch assignment.	Verify motherboard connection.

Problem: iS10 fails to operate.

Symptom	Possible Cause	Solution
iS10 fails to operate equipment.	iS10 is disabled.	See page 49 to enable the iS10
	Defective Wiring	Verify iS10 setup. Ensure the iS4 in question has the expected circuit assignments, and is not assigned to unused circuits.
	Incorrect configuration or button setup.	See page 43 to setup the iS10 buttons.
	Defective iS10	Replace defective iS10
iS10 fails to operate only some of the switches, but others work fine.	Defective wiring on one or more iS10 leads	Verify wiring on motherboard and iS10.
	Incorrect configuration or circuit to switch assignment.	Verify motherboard connection.

Problem: The Quick Touch remote will not work, or will not work dependably.

Symptom	Possible Cause	Solution
POWER LED does not light on the Receiver board located in the plastic clam shell.	EasyTouch Load Center does not have power	Ensure power is being supplied and that the power center operates correctly without the receiver installed
	Defective cable or connection to the Load Center	Verify the function of the board using known good cable set. Check all wiring
	Defective Receiver board	Contact Technical Support
COMM LINK LED does not light or blink. In normal operation LED will blink at least every 2 seconds	Defective cable or connection to the Load Center	Verify the function of the board using known good cable set
	Defective receiver board	Replace receiver board
Address switches are incorrectly configured	Verify that the address switches on the transmitter and handheld receiver board are correct and match	Transmitter battery has failed
	Replace Transmitter battery	Defective Transmitter or Receiver
Unit functions, but some circuits do not work, or operate the incorrect circuit	QuickTouch configuration is incorrect	See page 45 to setup buttons
Unit fails to operate, or fails to operate dependably at range	Excessive electrical noise	Relocate the receiver away from "noisy" electrical equipment such as blower motors
	Too many obstructions between the transmitter and receiver	Relocate the receiver away from ground metal and obstructions
	Receiver unit is too near the ground	Relocate the receiver to maximize the distance between the receiver antenna and the ground

Problem: The Quick Touch remote will not work, or will not work dependably (Continued).

Symptom	Possible Cause	Solution
Unit seems to turn on or off circuits without the user / transmitter	A near by home is operating a similar wireless unit	Select an alternate address code for the transmitter and receiver. Change the switches on both receiver and remote to an alternate, but matching setting.
Unit dependably turns equipment ON, but once equipment is running it does not dependably turn equipment OFF, or range is greatly reduced when equipment is running	Undue electrical noise is being produced by one or more pieces of equipment in close proximity to the receiver.	Relocate the Receiver away from equipment such as blower motors. Relocate the receiver in a location that provides fewer obstructions to the area the user commonly operates the transmitter.
Unit operates, but has greatly reduced range compared to prior function	Transmitter Battery is failing.	Replace Transmitter battery (type 2032 3V).

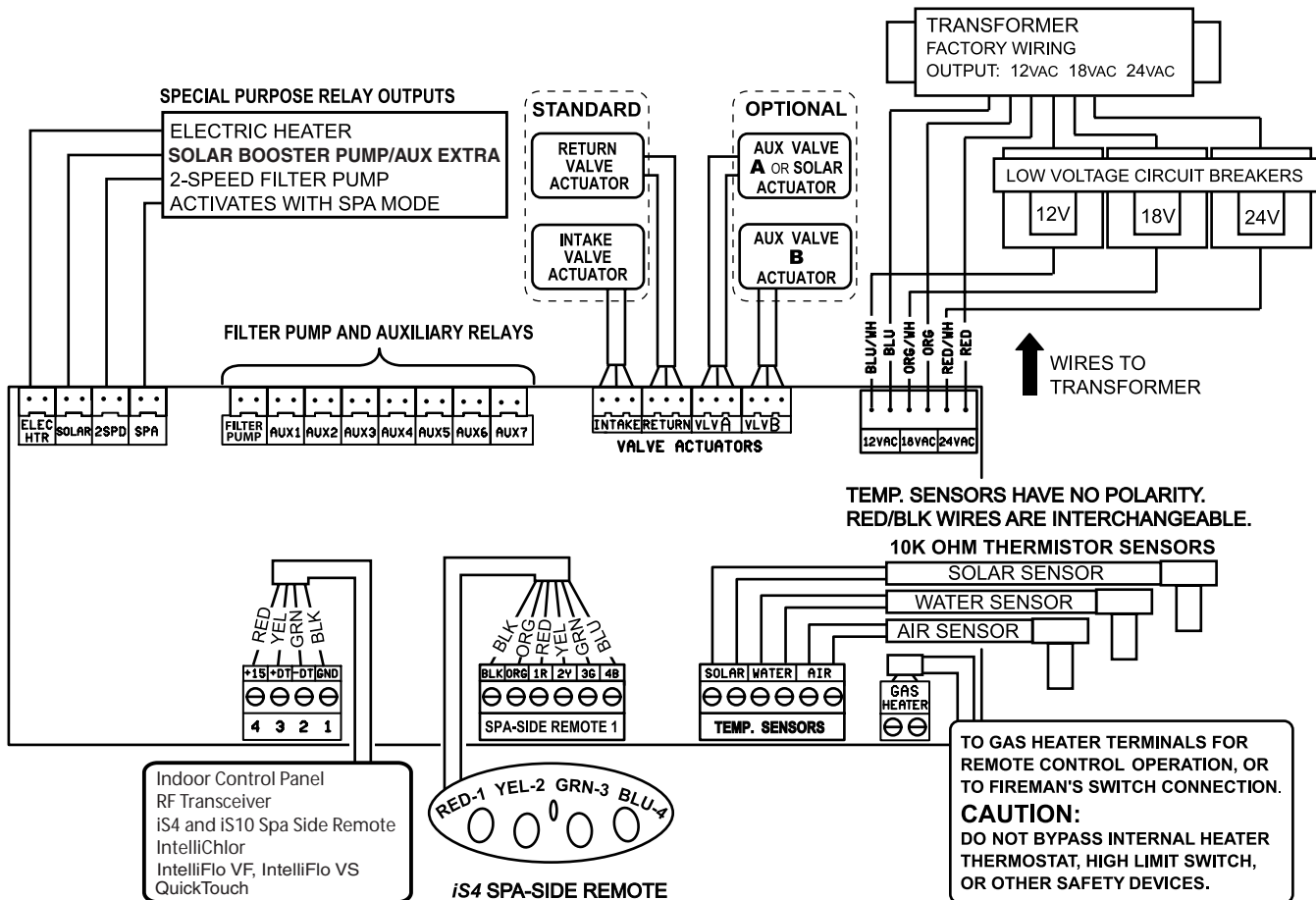

**EasyTouch Outdoor Control Panel
(System Wiring Diagram)**

First Time System Start-Up

The following information describes a basic system start-up procedure. Before you power up the EasyTouch system at the Load Center first check the following:

Check Electronics

Check that the following plugs are seated correctly on the EasyTouch Load Center motherboard. For connector locations, refer to the EasyTouch System Wiring Diagram on page 58.

- Relay connectors - **FLTR PUMP - AUX 1 - 7** (EasyTouch 8), **AUX 1 - 3** (EasyTouch 4)
- Temperature sensors connectors - **WATER, SOLAR, AIR**
- Transformer wire harness - **J1**
- Heater control connector - **ELEC HTR** and **GAS HEATER (J19)**

System Test

Follow the steps below to test the EasyTouch control panel to activate the heater, valves and pumps. This test assumes that all system equipment has been properly installed and connected to the EasyTouch Load center.

Testing Valve Actuators and Pumps:

Use the following steps to test the valve actuators (CVA24T) for proper rotation.

To test the valve actuators and pump:

1. Switch on the electrical power at the house breaker.
2. Switch on the EasyTouch Load Center. You may need to switch on the breakers on the Load Center.
3. Press the **Mode** button to enable “Service” mode.
4. Press the **Valve (V)** button to select “Pool” mode.
5. Press the **Filter Pump (F)** button to activate the filter pump. Water will be removed from the pool and returned to the pool. A spa bypass line divert a small amount of water to the spa. Make sure the filter pump turns on correctly. If the pump has two speeds: Press the button one time to run the pump in low speed. Press the button again to run the pump in high speed. Press the button again to switch the pump off. A Two-Speed pump has to be configured in the 2-Speed menu (see page 40).
6. Set both valve actuators (CVA-24T) for suction and return. Use the toggle switch on the rear of the CVA-24T to withdraw and return water from the pool.
7. Press the **Valves (V)** button. Step through all four valve positions: Pool, Spa, Fill, Drain. Make sure the valves turn on correctly and the water is moving in the correct direction for each position. If necessary, flip the actuator toggle switch to change the direction of the water.

Note: *With the filter pump operating, if water is not being removed and returned to the pool, it may be necessary to reverse the **RETURN** with **VLV A** (or **VLV B**) plugs on the EasyTouch motherboard.*

Testing the Auxiliary Relays

Affix the auxiliary relay labels to the appropriate buttons on the EasyTouch control panel and/or the EasyTouch Indoor Control Panel. If necessary, write the function on the control panel.

1. Step through the rest of the auxiliary buttons. Notice which button turns on which equipment. You may need to walk the property to find what each button turns on.
2. Write down what each button switches on, including the number of the circuit. You need this information when you set up the Indoor Control Panel.
3. Label the circuit buttons on the outdoor control panel and the EasyTouch Indoor Control Panel.

Wiring ThermalFlo to EasyTouch

Be sure to check the ThermalFlo terminal block wire colors and pinouts (located on the back of the Auto Set board) before connecting it to the EasyTouch COM port on the motherboard. See the wiring table below for the pin configuration.

IMPORTANT: On the ThermalFlo AutoSet board ONLY CONNECT PIN 3 (YELLOW) and PIN 2 (GREEN) to the EasyTouch COM port pins YELLOW and GREEN respectively. Do not use pin 1 or pin 4 on the AutoSet board or the EasyTouch motherboard. These pins are not used.

Wiring Description

EasyTouch COM port wire color	Description	ThermalFlo pin number and wire color
PIN 4 (RED) NOT USED	+15 VDC	PIN 4 (RED) NOT USED
PIN 3 (YELLOW)	+ DATA	PIN 3 (YELLOW)
PIN 2 (GREEN)	- DATA	PIN 2 (GREEN)
PIN 1 (BLACK) NOT USED	GROUND	PIN 1 (BLACK) NOT USED

EasyTouch Transceiver Installation

Installing the EasyTouch Transceiver

The following procedure describes how to install the EasyTouch transceiver module and connect the transceiver cable to the COM port on the EasyTouch motherboard. Read through the installation procedure before starting.

EasyTouch wireless control panel kit

The EasyTouch wireless control panel kit consists of:

- EasyTouch wireless control panel
- Four AA-size alkaline batteries
- Transceiver module
- Four plastic anchors and retaining screws (to mount the transceiver module)

Mounting the EasyTouch Transceiver

The Transceiver is a two-way radio device with an attached antenna that communicates to and from the EasyTouch system via the wireless hand-held wireless control panel. Mount the Transceiver module at a convenience location (on a flat vertical surface) near the Load Center, at a minimum of 5 ft. above ground level to optimize the functional operating range of the wireless control panel.

⚠ CAUTION - To avoid signal interference, mount the Transceiver antenna a minimum of 10 ft. away from the Load Center, any metal surface/structure, or air blower located in the immediate area of the equipment pad.

To mount the EasyTouch transceiver near the EasyTouch load center:

1. **⚠ CAUTION** - **Switch the main power off at the EasyTouch load center.**
2. Remove the two retaining screws securing the transceiver case to the back plate. Carefully slide the case off the back plate.
3. **⚠ CAUTION** - **Electrostatic Discharge (ESD): Hold the circuit board from the edges. Do not touch the board components, electrostatic discharge can damage the board.** Slide the transceiver circuit board up and out of the back plate.
4. Position the back plate against the mounting surface so that the case is oriented in an upright position (with the antenna pointing upwards). Use a pencil to mark the four mounting points. Drill four 3/16 in. diameter holes into the mounting surface. If screws are not being used, insert the four plastic wall anchors (provided in the kit).
5. Feed the provided 10 ft. of UL approved four 22 AWG conductor cable through the knockout hole at the bottom of the enclosure. Do not run wire through the drain holes. If the knockout hole is not being used to run wire through, drill a hole through the bottom of the back plate, route the wire through the hole and seal it using a fitting with a few feet of conduit or some other sealant between the case and the cable.

6. Position the back plate over the mounting points and secure it with the four mounting screws (provided in the kit).
7. Carefully slide the transceiver circuit board into the back plate.
8. Strip the leads of the communication cable wires back $\frac{1}{4}$ in. Insert the wires into the connector screw terminals (provided in the kit). Using a small flat-blade screwdriver, secure the wires with the terminal screws. Make sure to match the color-coding of the wires: GND = Black, Green = -DT, Yellow = +DT, and Red = +15. Connect the screw terminal connector onto the transceiver circuit board.
9. Slide the case over the back plate. Secure the case to the back plate using the two retaining screws.
10. Proceed with **“Connecting the Transceiver to the EasyTouch Load Center,”** on page 63.

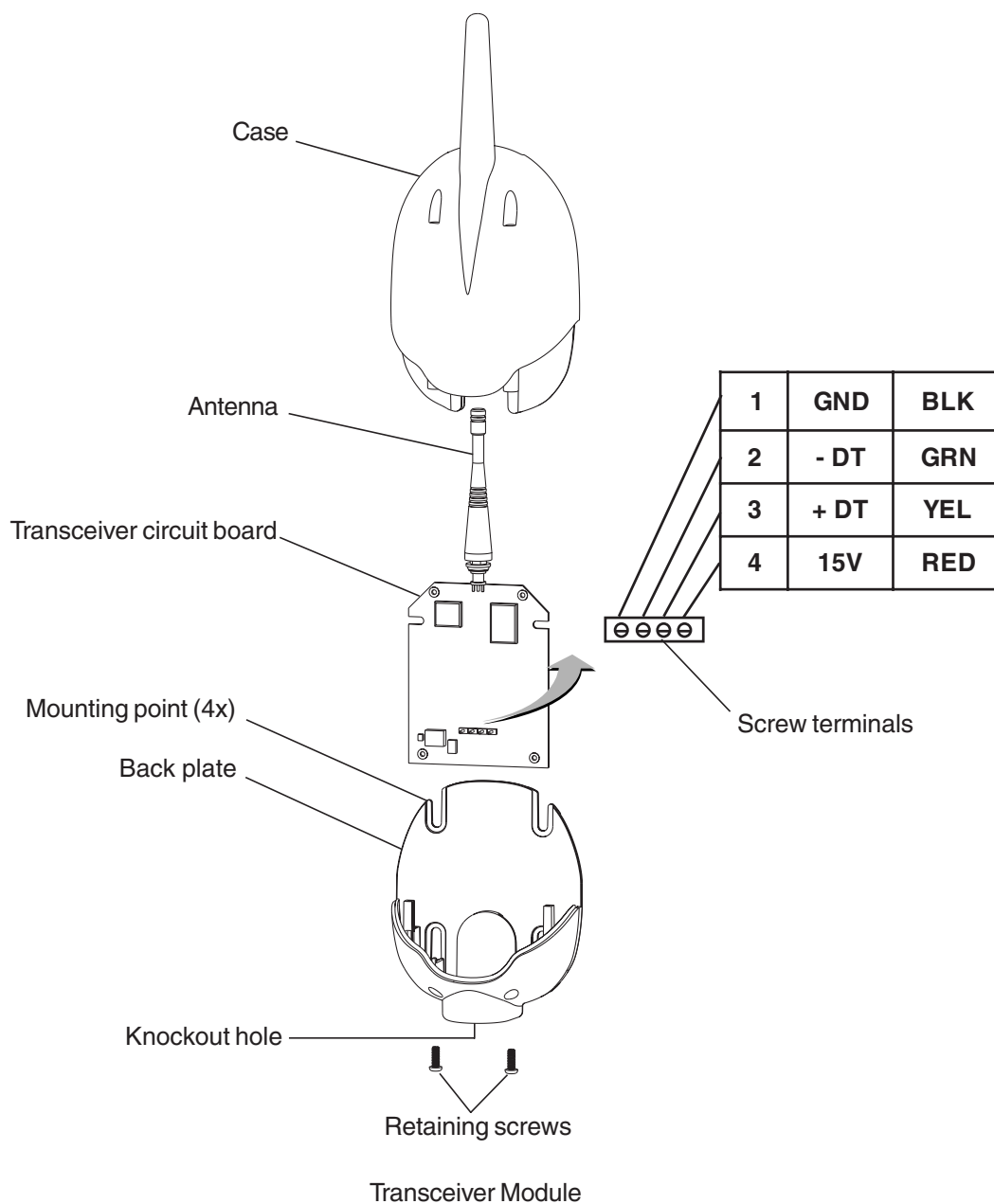

Connecting the Transceiver to the EasyTouch Load Center

⚠ WARNING - Switch OFF the main system power to the EasyTouch load center before making any connections.

1. Unlatch the two enclosure door spring latches, and open the door.
2. Remove the two retaining screws securing the high voltage cover panel, and remove it from the enclosure.
3. Loosen the two access screws securing the control panel.

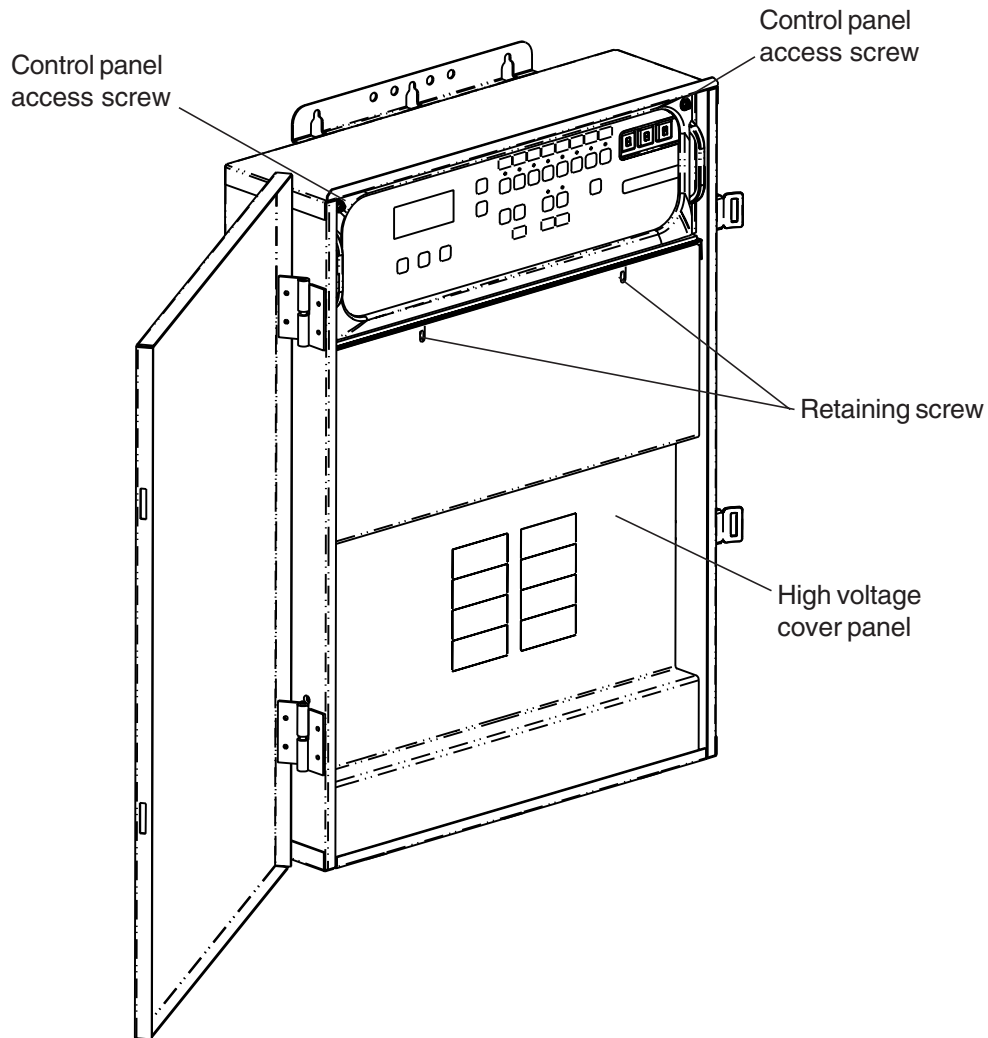

EasyTouch Load Center (front view)

4. Lower down the hinged control panel to access the EasyTouch motherboard.
5. Route the four conductor transceiver connection cable into the lower plastic grommet, up through the low voltage raceway to the EasyTouch load center motherboard.
6. Strip back the cable conductors $\frac{1}{4}$ inch. Insert the wires into the screw terminals (provided in the kit). Secure the wires with the screws. Make sure to match the color-coding of the wires: GND = Black, Green = -DT, Yellow = +DT, and Red = +15
7. Insert the screw terminal connector onto the **COM-PORT (J20)** connector on the motherboard.
Note: Multiple wires may be inserted into a single screw terminal.

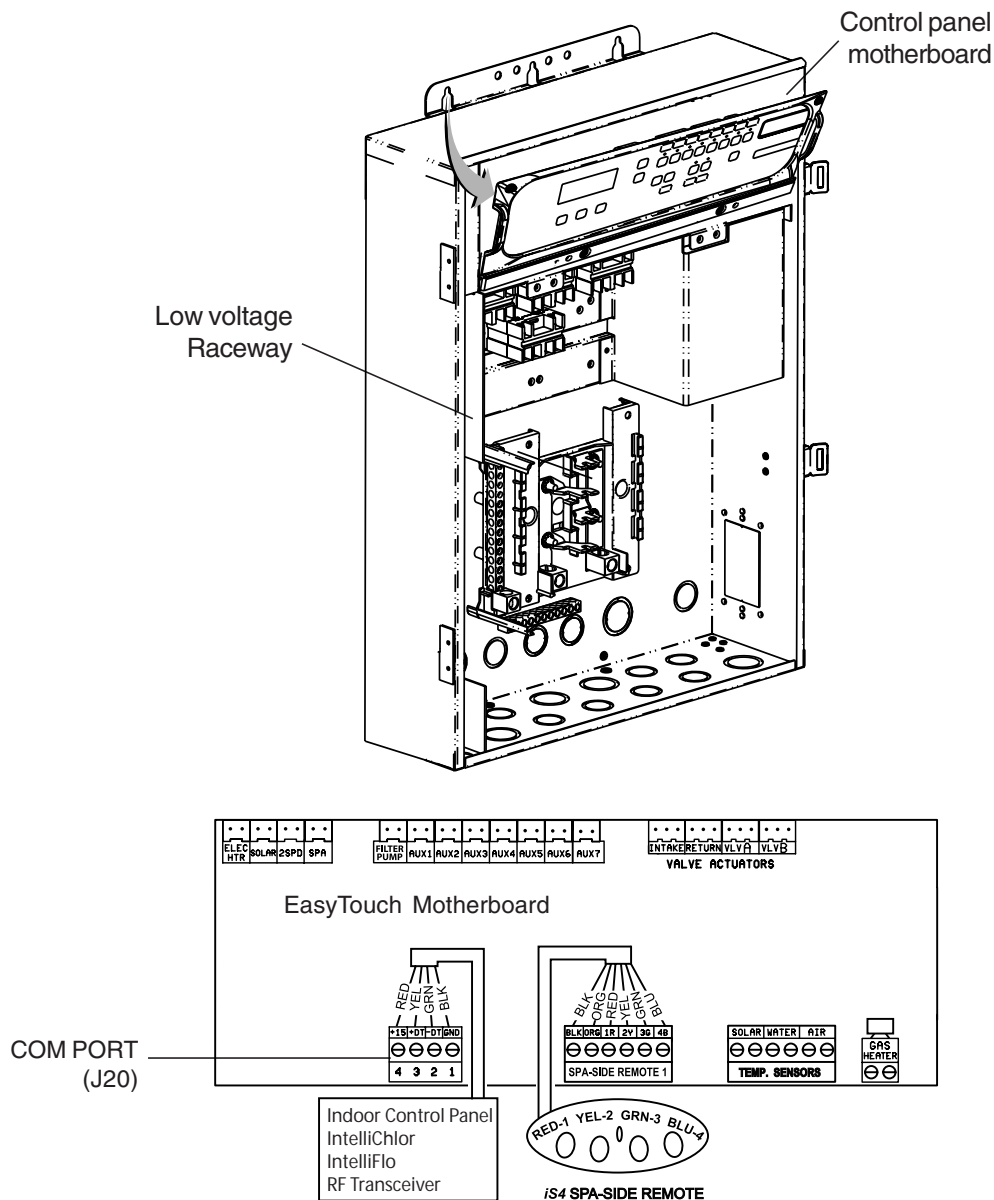

8. Close the control panel into its original position and secure it with the two access screws.
9. Install the high voltage cover panel and secure it with the two retaining screws.
10. Close the EasyTouch load center front door. Fasten the two spring latches.
11. Switch the power on to the EasyTouch load center.

Glossary

Aux Extra: An additional auxiliary output circuit that uses the Solar socket (J17) on the EasyTouch motherboard. Uses the Down arrow button on the wireless control panel to switch circuit on and off. Only available if solar equipment is not being used.

COM port: RS-485 communication port for connection to iS10 spa-side remote controller, ThermalFlo heat pump, EasyTouch Indoor Control Panel, IntelliChlor, IntelliFlo and QuickTouch RF transceiver. A four pin terminal block located on the EasyTouch motherboard.

High Voltage Compartment: Large lower right compartment of Load Center for all high voltage wiring including circuit breakers, relays, and GFCI.

Wireless Control Panel: Nine or 14 button remote controller with LCD (liquid crystal display) wired to the EasyTouch motherboard in the load center.

iS4: Four function Spa-Side remote. Can be spa wall or deck mounted.

Load Center: Metal enclosure with power relays, transformer, and circuit breakers. Used for distributing power for controlling the EasyTouch system. Also known as the “sub-panel.”

Low Voltage Compartment: Top compartment of Load Center for all low voltage wiring.

Low Voltage Raceway: Vertical space in the left side of EasyTouch load center for low voltage cabling.

Motherboard: The circuit board mounted on top of the EasyTouch control panel. The EasyTouch motherboard defines the system capabilities.

Outdoor Control Panel: EasyTouch control panel with flexible hinge installed in upper portion of EasyTouch Load Center to control the EasyTouch system.

Receiver/Antenna: Used with the QuickTouch (QT4) to receive radio frequency (wireless) transmissions.

RF Transceiver: Used with the EasyTouch wireless control panel to transmit and receive radio frequency (wireless) transmissions.

Relay Circuits: The circuits that control the relay outputs on the EasyTouch motherboard. Connectors are located on the top edge of the circuit board.

Screw Terminal Connector: Removable connector that may attach to circuit board with multiple sockets (anywhere from 2 to 12) to receive wires from controllers and sensors; wires held by screw terminals; multiple wires of a small enough gauge (usually 22 AWG) may be coupled to a single socket of a terminal connector. Sockets are located on the EasyTouch motherboard.

Blank Page



P/N 520688 - Rev C